

Agilent N9310A RF Signal Generator

User's Guide



Agilent Technologies

Notices

© Agilent Technologies, Inc. 2006

No part of this manual may be reproduced in any form or by any means (including electronic storage and retrieval or translation into a foreign language) without prior agreement and written consent from Agilent Technologies, Inc. as governed by United States and international copyright laws.

Edition

Second Edition, April 2007

Printed in China

Agilent Technologies, Inc.
Hi-Tech Industrial Development Zone (West District)
Chengdu 611731, P.R.C

Software Revision

This guide is valid for A.02.00 revisions of the Agilent N9310A RF Signal Generator software.

Warranty

The material contained in this document is provided “as is,” and is subject to being changed, without notice, in future editions. Further, to the maximum extent permitted by applicable law, Agilent disclaims all warranties, either express or implied, with regard to this manual and any information contained herein, including but not limited to the implied warranties of merchantability and fitness for a particular purpose. Agilent shall not be liable for errors or for incidental or consequential damages in connection with the furnishing, use, or performance of this document or of any information contained herein. Should Agilent and the user have a separate written agreement with warranty terms covering the material in this document that conflict with these terms, the warranty terms in the separate agreement shall control.

Technology Licenses

The hardware and/or software described in this document are furnished under a license and may be used or copied only in accordance with the terms of such license.

Restricted Rights Legend

U.S. Government Restricted Rights. Software and technical data rights granted to the federal government include only those rights customarily provided to end user customers. Agilent provides this customary commercial license in Software and technical data pursuant to FAR 12.211 (Technical Data) and 12.212 (Computer Software) and, for the Department of Defense, DFARS 252.227-7015 (Technical Data - Commercial Items) and DFARS 227.7202-3 (Rights in Commercial Computer Software or Computer Software Documentation).

Safety Notices

CAUTION

A **CAUTION** notice denotes a hazard. It calls attention to an operating procedure, practice, or the like that, if not correctly performed or adhered to, could result in damage to the product or loss of important data. Do not proceed beyond a **CAUTION** notice until the indicated conditions are fully understood and met.

WARNING

A **WARNING** notice denotes a hazard. It calls attention to an operating procedure, practice, or the like that, if not correctly performed or adhered to, could result in personal injury or death. Do not proceed beyond a **WARNING** notice until the indicated conditions are fully understood and met.

Contents

1	Overview	1
	Agilent N9310A At a Glance	2
	Front Panel Overview	4
	Front Panel Display	7
	Rear Panel Overview	9
	Front and rear panel symbols	11
2	Getting Started	13
	Check the Shipment and Order List	14
	Safety Notice	17
	Environmental Requirements	18
	Electrical Requirements	19
	Power on and Check	22
	Some Tips	25
	Enable an option	25
	Remote Control	26
	Firmware Update	27
	Connectors Maintenance	28
3	Using Functions	29
	Commonly used Front-panel Elements	30
	Generating a CW Signal	31
	Generating a Step Swept Signal	32

Contents

Generating a List Swept Signal	39
Generating a Modulated Signal	41
Generating an LF Output	49
Save, Recall and Delete an Instrument State	50
4 Key Reference	53
AM	54
Amplitude	57
Arrow Keys	58
Enter	58
File	59
FM	61
Frequency	64
I/Q (Option 001 only)	64
LF Out	65
Mod On/Off	66
RF On/Off	66
Numeric Keypad	66
Phase Modulation	67
Switch	69
Preset	70
Pulse	71
Sweep	73
Trigger	82
Utility	83
5 Programming Fundamentals	87
Remotely Operating Your N9310A	88
Getting Started with SCPI	93
IEEE 488.2 common command	101

6	Subsystem Command Reference	103
	Preparing for Use	104
	Frequency Subsystem	107
	Amplitude Subsystem	111
	Trigger Subsystem	113
	Sweep Subsystem	114
	AM Subsystem	130
	FM Subsystem	133
	Phase Modulation Subsystem	136
	Pulse Modulation Subsystem	138
	I/Q Modulation Subsystem	140
	Utility Subsystem	141
	Modulation State Subsystem	145
	RF Output State Subsystem	146
	LF Output Subsystem	147
	Subsystem Command Trees	149
	Programming Examples	159
	Programming in C using the VTL	160
	Example 1 - Checking USB Connection	162
	Example 2 - Generating a CW signal	164
	Example 3 - Generating an AM Signal	166
	Example 4 - Generating an continuous RF Sweep	168
7	Instrument Messages	171
	Overview	172
	Command Errors	173
	Execution Conflict	176

Contents

System Errors 177

Hardware Errors 178

8 Supplementary Information 179

Check the Basics 180

Read the warranty 181

Contact Agilent Technologies 182

List of Commands 183

Index 187



1 Overview

Check the Shipment and Order List	14
Safety Notice	17
Environmental Requirements	18
Electrical Requirements	19
Power on and Check	22
Some Tips	25
Connectors Maintenance	28

This chapter describes the general features and functions of the Agilent N9310A RF Signal Generator and provides an introduction to the front and rear panel.

Agilent N9310A At a Glance

An Agilent N9310A RF Signal Generator finds general purpose applications in manufacturing, service, development and education.

The signal generator comprises an optional broadband I/Q modulator, which is able to generate digital signals in conjunction with an external I/Q source.

General Features and Functions

The Agilent N9310A RF Signal Generator provides:

- 9 kHz to 3 GHz frequency range
- -127 to +13 dBm (+20 dBm settable) level range
- Built in AM, FM, Φ M, and pulse modulation
- RF sweep, LF sweep and amplitude sweep
- 0-3 V_p LF output (into 50 Ω)
- 6.5-inch TFT LCD
- Universal USB interface
- 1-year calibration cycle

Options

This section provides an overview of available options. For details, please refer to <http://www.agilent.com/find/n9310a>.

- Option 001: I/Q modulator
(part number: N9310A -001)

This option provides an additional internal I/Q modulator. Using this option in the signal generator generates digital signals. Option 001 also requires an external I/Q baseband signal input.

- Option 1CM: Rackmount flange kit
(part number: N9310A -1CM)



Use a rackmount kit to facilitate installation in a standard rack.

- Option 1TC: Hard transit case
(part number: N9310A -1TC)

A hard transit case protects the signal generator during transportation and storage.

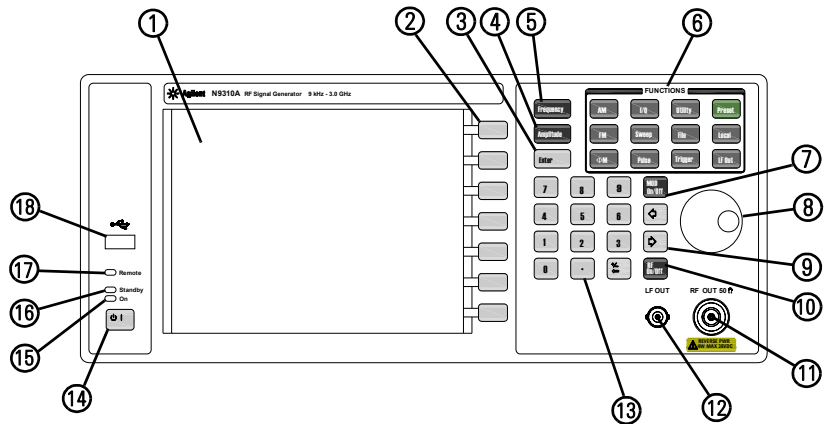
Front Panel Overview





- 1 **Display** The LCD screen shows information on the current function. Information includes status indicators, frequency and amplitude settings, and error messages. Labels for softkeys are located on the right-hand side of the display. For further description of the front panel display, refer to [“Front Panel Display”](#) on page 7
- 2 **Softkeys** Softkeys vary in function. They activate functions displayed to the left of each key. Refer to [Chapter 4, “Key Reference,”](#) starting on page 53 for further information.
- 3 **Enter** The  hardkey terminates data entry field or parameter selection. It also triggers a single sweep.
- 4 **Amplitude** Pressing  hardkey allows you to edit the CW (continuous wave) amplitude.
- 5 **Frequency** Pressing  hardkey allows you to edit the CW Frequency.
- 6 **Function keys** These hardkeys connect directly to the following main functions:
 - **Preset** sets the signal generator to factory default settings.
 - **AM** configures an amplitude modulation.

- **FM** configures a frequency modulation.
- **ΦM** configures a phase modulation.
- **Pulse** configures a pulse modulation.
- **I/Q** activates an I/Q modulation.
- **Sweep** configures RF/LF/Amplitude sweep.
- **Trigger** triggers an armed sweep.
- **Utility** sets the system configurations
- **Local** returns the signal generator from remote to local.
- **File** saves, recalls or deletes customized configuration files.
- **LF Out** configures a low frequency signal.

- 7 Mod On/Off** Pressing  hardkey toggles the modulator state between On and Off. A **MOD On/Off** annunciator is visible on the screen, indicating whether the modulator is enabled or not.

You also have to activate each individual modulation (for example,  > **AM On**), otherwise no modulation is applied to the output carrier signal, even though the modulator is enabled (**MOD On**).

- 8 Knob** The knob increases or decreases a value or a numeric digit, or moves to select an item up and down in a list.
- 9 Arrow keys** The left and right arrow keys shift the selected digit in the active entry area of the display; Once an individual digit is selected, you can change its value by rotating the knob.
- 10 RF On/Off** The  hardkey toggles the RF output state between On and Off. A **RF On/Off** annunciator is always visible on the display, indicating whether the RF output is enabled or not.
- 11 RF Out connector** This female N-type connector provides the output for RF signals. The impedance is 50 ohm. The damage level is +36 dBm maximum.

- 12 **LF Out connector** This BNC connector outputs the low frequency (LF) signal whenever you set the  > **LF OUT** to on. The LF output is capable of driving 3 V_{peak} (nominal) into a 50 ohm load.
- 13 **Numeric Keypad** includes 0 through 9, a decimal point and a backspace key. The backspace hardkey also enables you to specify a negative value. When specifying a negative numeric value, enter a negative sign prior to entering the numeric value.
- 14 **Standby Switch** switches on all functions of the signal generator. When pressing this key to switch the signal generator Off, the signal generator deactivate all the functions but still remains connected to the line power, while the line power is supplied to some internal circuits.
- 15 **Switch On LED** This green LED lights when the signal generator is switched on.
- 16 **Standby LED** This orange LED lights when the signal generator is connected to the line power.
- 17 **Remote LED** This LED lights when the signal generator is remotely controlled by a PC via the USB host interface on the rear panel.
- 18 **USB Device Connector** provides a connection between external USB devices and the signal generator, such as a USB memory stick.

Front Panel Display

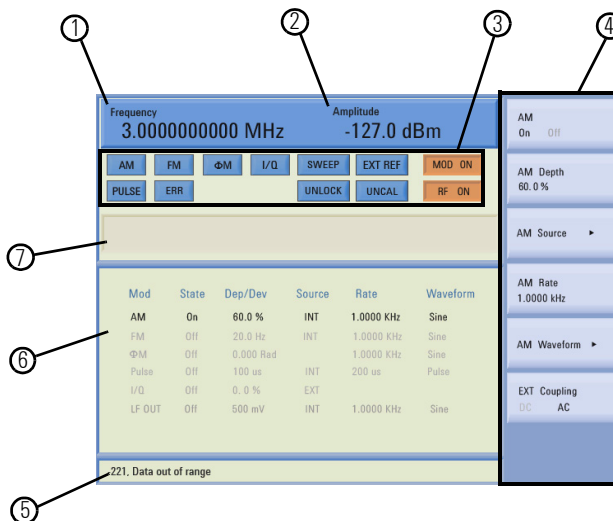

- 1 Frequency Area** displays the current CW (continuous wave) frequency.
- 2 Amplitude Area** displays the current output power level.
- 3 Annunciators** display the status of most of the signal generator functions, as well as indicating errors generated. An annunciator position may be used by more than one function.
 - Φ M becomes active when Φ M is enabled.
 - AM becomes active when an AM is enabled.
 - ARMED becomes active when a sweep mode is selected and the signal generator is waiting for a trigger to initiate sweeping.
 - ERR becomes active when an error is generated. This annunciator will not turn off until you have viewed all the error messages and cleared the error queue. You can access error messages by pressing **Utility** > **Error Info**.

- **EXT REF** becomes active when an external frequency reference is applied.
 - **FM** becomes active when an FM is enabled.
 - **I/Q** becomes active when an I/Q modulation is enabled.
 - **MOD ON/OFF** indicates if the RF carrier is modulated or not (**MOD ON** indicates the modulator is enabled, while **MOD OFF** indicates disabled). Either state is always visible on the screen.
 - **PULSE** becomes active when a pulse modulation is enabled.
 - **RF ON/OFF** indicates whether the RF output is enabled or disabled. Either state is always visible in the display.
 - **SWEEP** becomes active when the signal generator is sweeping.
 - **UNCAL** becomes active when the signal generator is unable to maintain the correct level.
 - **UNLOCK** becomes active when any of the phase locked loops are unable to maintain phase lock. To view further descriptions, please refer to “[Instrument Messages](#)” on page 171.
- 4 Softkey Label** displays submenus of each function. The content of softkey labels change according to the function selected. Refer to [Chapter 4](#), “Key Reference,” starting on page 53 for further information.
 - 5 Message Area** displays abbreviated system messages. When multiple system messages occur, only the most recent message is displayed. Press **Utility** > **Error Info** to view all reported system messages along with details.
 - 6 Status Area** displays state information about the signal generator, such as the modulation status, sweep status, and file catalogs and storages.
 - 7 Active Function Area** displays the current active function. For example, if you press **Frequency** hardkey, the frequency is active and the current frequency setting is displayed.

Rear Panel Overview

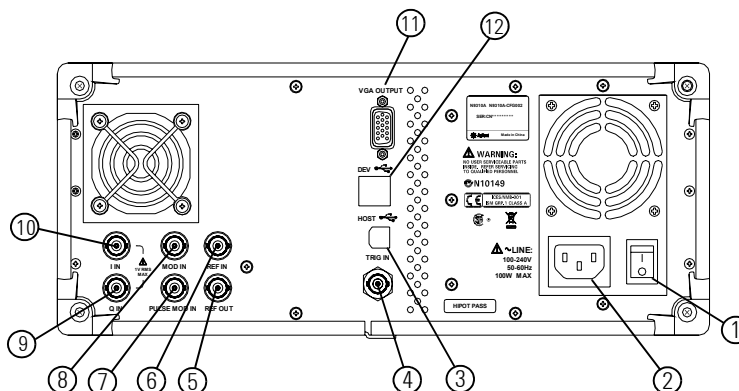

- 1 **Power switch** The power switch isolates the signal generator from the AC line power. After switching on this switch, the signal generator enters into standby and the orange standby LED on the front panel is turned on.
- 2 **AC power receptacle** The power receptacle accepts a three-pin plug.
- 3 **USB Host connector** Used for connecting with a controller, such as a PC.
- 4 **TRIG IN connector** Female BNC connector, accepts a TTL signal for triggering an sweep. Triggering occurs on either the positive or negative edge. The frequency of the external trigger source is no greater than 100 Hz. The damage level is $\geq +10$ V or ≤ -4 V.
- 5 **REF OUT connector** Female BNC connector is for a output of the internal reference frequency, which has a nominal output level greater than $0.35V_{rms}$, and an output impedance of 50 ohm.

- 6 **REF IN connector** Female BNC connector, accepts a -3.5 to +20 dBm signal from an external reference oscillator that is within ± 1 ppm. The nominal input impedance is 50 ohm. The connector accepts 2MHz, 5MHz, 10 MHz signal according to your selection.
- 7 **PULSE MOD IN connector** This BNC input connector accepts a TTL signal for pulse modulation. The damage level is 5 Vrms.
- 8 **MOD IN connector** This BNC input connector accepts a $1.0 \pm 2\%$ V (peak) signal for AM, FM, and phase modulation. For all these modulations, +1.0 V_{peak} produces the indicated deviation or depth. The damage level is 5 Vrms.
- 9 **Q IN connector** This female BNC input connector accepts an external quadrature-phase component of an I/Q baseband signal. The signal level is $\sqrt{I^2 + Q^2} = 0.5$ Vrms for calibrated output level. The input impedance is 50 Ohm. The damage level is 1 Vrms.
- 10 **I IN connector** This female BNC input connector accepts an externally in-phase component of an I/Q modulation signal. It has the same characters with the Q baseband signal.

NOTE

The I/Q IN connector is just available for external I/Q signal input with the Option 001.

- 11 **VGA connector** connects to an external monitor or projector.
- 12 **USB device connectors** connect with external USB devices, such as a USB memory stick.

Front and rear panel symbols

The signal generator has the following symbols. Before operation, familiarize yourself with each marking and its meaning.



The instruction manual symbol: indicates that the user must refer to specific instructions in the manual.



The CE mark: a registered trademark of the European Community.

ISM1-A

shows that this is an Industrial Scientific and Medical Group 1 Class A product. (CISPR 11, Clause 4)



The CSA mark: a registered trademark of the Canadian Standards Association International.

ICES/NMB-001

The ISM device complies with Canadian Interference-Causing Equipment Standard-001.
Cet appareil ISM est conforme à la norme NMB-001 du Canada.



The C-Tick Mark: a trademark registered to the Australian Communication Media Authority. It indicates compliance with all Australian EMC regulatory information.



marks the “on” position of the power line switch.



marks the “standby” position of the power line switch.



indicates that the instrument requires AC power input.

1 Overview



This product complies with the WEEE Directive(2002/96/EC) marking requirements. The affixed label indicates that you must not discard this electrical/electronic product in domestic household waste.

Product Category: With reference to the equipment types in the WEEE Directive Annex 1, this product is classed as a Monitoring and Control instrumentation product.

Do not dispose in domestic household waste. To return unwanted products, contact your local Agilent office, or see

<http://www.agilent.com/environment/product/>



2 Getting Started

Check the Shipment and Order List	14
Safety Notice	17
Environmental Requirements	18
Electrical Requirements	19
Power on and Check	22
Some Tips	25
Connectors Maintenance	28

This chapter gives you the information you will need, in most cases, to configure connections to your instruments and interfaces and start using the signal generator properly.

Check the Shipment and Order List

As you receive the shipment, please refer to the following procedures, check the shipment and your order list . If your doubted about the shipment, please contact Agilent Technologies Customer Contact Center for consultation and service.

- Inspect the shipping container for damage. Signs of damage may include a dented or torn shipping container or cushioning material that indicates signs of unusual stress or compacting.
- Carefully remove the contents from the shipping container and verify that your order is complete. Each shipment includes the following items as standard:

Item	Quantity	Part Number
N9310A signal generator	1	N9310A
USB cable	1	8121-1482
Three-pin power cord	1	Specific to region
Quick Start Guide	1	N9310-90003
User's Guide	1	N9310-90001
Help kit CD-ROM	1	N9310-84500
Calibration certificate	1	5962-0476

- If you ordered any of the following options, verify if they are in the shipment by checking the product label on the rear panel and the package checking list.

Option	Name	Part number
001	I/Q modulator	N9310A-001
1CM	Rackmount kit	N9310A-1CM
1TC	Hard transit case	N9310A-1TC

Rack Mount

You are recommended to rackmount kit (option 1CM) to install the signal generator into a rack.

Do not attempt to rack mount the signal generator by the front panel handles only. This rackmount kit allows you to mount the signal generator with or without handles.

Refer to the following instructions when you want to rackmount the signal generator.

- 1 Remove feet, key-locks and tilt stands.
- 2 Remove side trim strips and a middle screw per side.

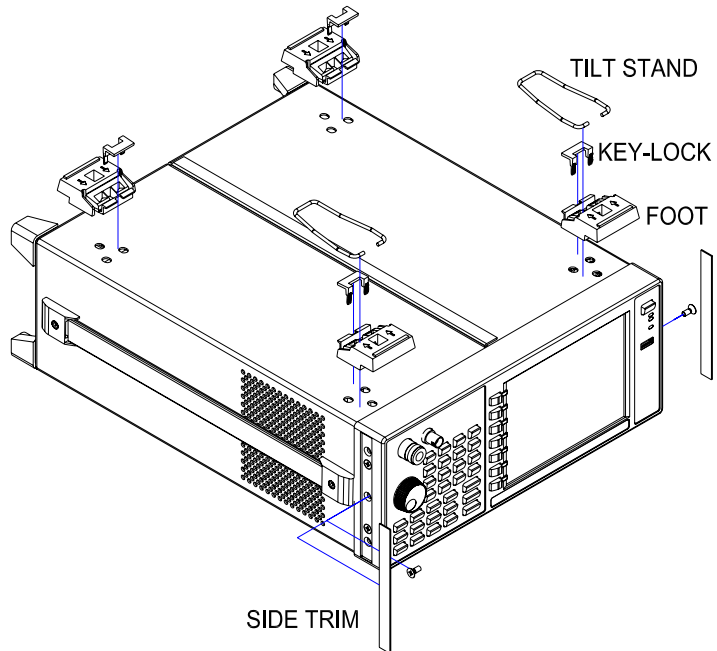

- 3 Attach rackmount flange and front handle assembly with 3 screws per side.

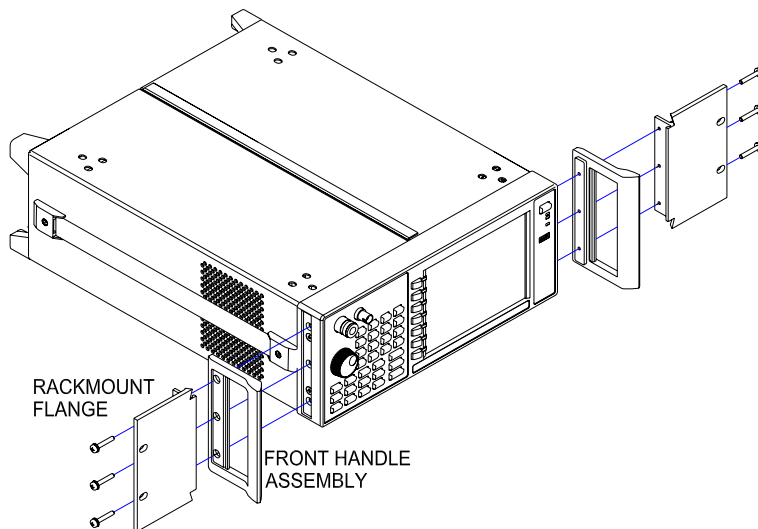

- 4 Rackmounting with two dress screws per side.

CAUTION

Installing the signal generators into other racks may promote shock hazards, overheating, dust contamination, and inferior system performance. Consult your Agilent customer engineer about installation, warranty, and support details.

Transit

You are also recommended to use the hard transit case (option 1TC) for instrument transportations.

Safety Notice

Please read the following warnings and cautions carefully before you power on the signal generator to ensure your personal and instrumental safety.

WARNING

Always use a well-grounded, three-pin AC plug and power cord to connect to a power source. Personal injury may occur if there is any interruption of the AC power cord of the signal generator. Intentional interruption is prohibited.

WARNING

Personal injury may result if the signal generator covers are removed. There are no operator service parts inside. To avoid electrical shock, refer servicing to qualified personnel.

WARNING

Electrical shock may result if the signal generator is connected with the power supply when cleaning. Do not attempt to clean internally.

CAUTION

Installing the signal generator in other racks may promote shock hazards, overheating, dusting contamination, and inferior system performance. Consult to your Agilent customer engineer about installation, warranty, and support details.

CAUTION

Damage to the signal generator may result when the total power dissipated in the cabinet is greater the 800 watts. When this condition exists, forced convection must be applied.

CAUTION

Avoid turning off the signal generator when current state is changing as a result of front panel operation or remote control.

Environmental Requirements

Agilent Technologies has designed this product for use in Installation Category II, POLLUTION DEGREE 2, per IEC 61010-1. Agilent has designed the signal generator for use under the following conditions:

- Indoor use
- Altitude < 3,000 meters
- Temperature 0 to 45°C, unless otherwise specified
- 15% to 95% relative humidity for temperatures at 40°C

Ventilation

Ventilation holes are located on the rear panel and all four sides of the signal generator cover. Do not allow these holes to be obstructed, as they allow air flow through the signal generator.

When installing the signal generator in a cabinet, do not restrict the convection into and out of the signal generator. The ambient temperature outside the cabinet must be less than the maximum operating temperature of the signal generator by 4°C for every 100 watts dissipated within the cabinet.

Cleaning Tips

To prevent electrical shock, disconnect the signal generator from mains before cleaning. Use a dry cloth or one slightly dampened with water to clean the external case parts. Do not attempt to clean internally.

WARNING

Electrical shock may result if the signal generator is connected from the power supply while cleaning. Do not attempt to clean internally.

Electrical Requirements

The signal generator has an auto-ranging line voltage input. The available AC power source must meet the following conditions:

Voltage:	100~240 volts nominal
Frequency:	50/60 Hz nominal
Power:	100 watts maximum





Connecting the AC Power Cord

This is a Safety Class I Product provided with a protective earth ground incorporated into the power cord. The front panel switch is only a standby switch; it is not a power switch. The AC power cord is the disconnecting device that disconnects the signal generator mains circuits from the mains supply. Alternatively, The rear panel switch or circuit breaker may also be used as a disconnecting device.

Perform the following steps to connect the AC power cord:

- Ensure that the power cord is not damaged.
- Install the signal generator so that you can easily reach the AC power cord or circuit breaker.
- Insert the main plug into a socket outlet provided with a protective earth grounding.

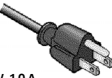
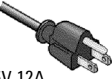
AC Power Cord Localization

Plug Type	Cable Part Number	Plug ^a Description	For Use in Country & Region
 250V 10A	8121-1466	BS 1363/A	Option 900 United Kingdom, Hong Kong, Singapore, Malaysia
 250V 10A	8120-1454	KS C8305	Option 902 Korea
 250V 10A	8120-1378	CNS 10917-2	Option 903 United States, Canada, Taiwan
 125V 12A	8120-4754	JIS C8303	Option 918 Japan
 250V 10A	8120-8377	GB 1002	Option 922 China

a. Plug identifier numbers describe the plug only. The part number is for the complete cable assembly.

Electrostatic Discharge Protection

Electrostatic discharge (ESD) damages or destroys electronic components (the possibility of unseen damage caused by ESD is present whenever transportation, store or use of components).

This product contains components that are easily damaged by Electrostatic Discharge (ESD). To help reduce ESD damage that can occur while using test equipment:

- 1** Each day, before connecting any coaxial cable to the signal generator connector for the first time, momentarily short the center and outer conductors of the cable together.
- 2** Before touching the center pin of any connector, and before removing any assembly from the signal generator, ground users with a 1 M Ω resistor-isolated wrist-strap.
- 3** Be sure that all instruments are properly grounded to prevent build-up of static charge.

For more information about ESD and how to prevent ESD damage, contact the Electrostatic Discharge Association (<http://www.esda.org>). The ESD standards developed by this agency are sanctioned by the American National Standards Institute (ANSI).

Power on and Check

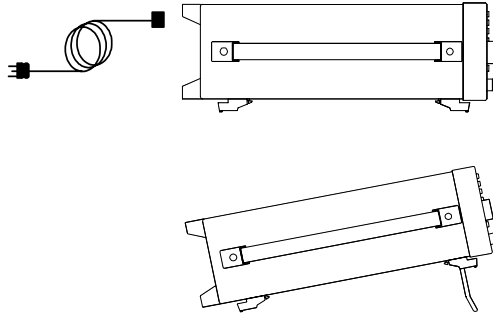

- 1 Connect the power cord. Insert the plug into a power socket provided with a protective earth. Set the tilt adjustor for your preference.

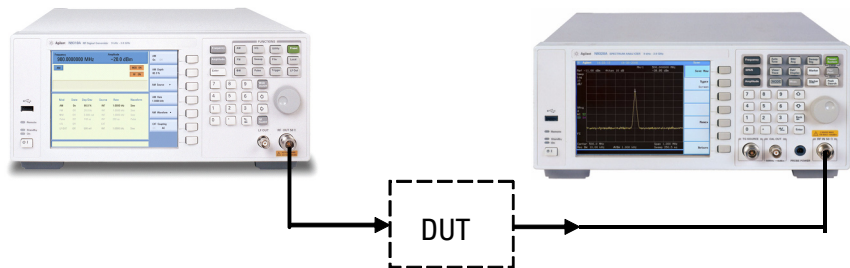

- 2 Connect a cable to the output connector of the signal source and then connect the cable to your DUT (device under test).



Turn On the Signal Generator

- 1 Toggle the line switch  to on the rear panel to On state. The orange standby LED will light and the signal generator has connected with the AC line power.
- 2 Press the standby switch  on the front panel. The green Switch On LED will light and the signal generator boots up.

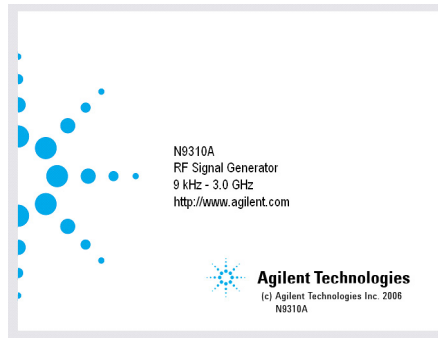

Self-initialization takes about 30 seconds, including self-test. If it detects an error, it reports an error message. The signal generator then defaults to a maximum frequency of 3 GHz and a minimum amplitude of -127 dBm, then the signal generator is ready for your current use. After power on, let the signal generator warm up for 45 minutes for stabilization.

NOTE

The front panel switch is a standby switch only; it is not a power switch. To disconnect the signal generator from the line power, turn off the power switch on the rear panel.



Check for Error Messages

The signal generator has two categories of instrument messages: system messages and error messages. A system message is triggered by operation errors, for example, setting conflicts or data input is out of the range of a parameter. An error message mainly is triggered by hardware defects and has an ERR annunciator displaying on the screen.

In condition of a operation error occurs, the signal generator reports a message at the bottom of the screen, indicating an operation error occurred and the instrument has corrected the error. The signal generator also automatically clears the system messages 30 seconds later.

In condition of hardware defects or system error occurs, the signal generator reports a message at the bottom of the screen and also has an ERR annunciator displaying.

Here are some tips for you to check the signal generator for error messages.

- 1 Check the display to see if the ERR annunciator is displayed. If it is, press  > **Error Info** to review each error messages in the queue. Please refer to [Chapter 7](#), “Instrument Messages” for detailed system messages descriptions.
- 2 When you have reviewed and resolved all of the error messages, press  > **Error Info** > **Clear** softkey to delete the messages.
- 3 Cycle the power on the signal generator and then check again if the ERR annunciator is still there.
- 4 If you can not resolve all error messages, please contact Customer Contact Center for service.

Some Tips

Refer to the following hints to set up the signal generator for your preference. For more detailed description, see “Utility” on page 83.

- Set the screen saver on by pressing **Utility** > **Screen Saver**> **On**
With the screen saver set to **On**, the display light turns off after 15 minutes with no input from the front panel. The display light turns on when pressing any front panel key.
- Select a display style by pressing **Utility** > **Display Style**

NOTE

The display style and the screen saver are persistent state, pressing **Preset** hardkey will not affect these settings.

- Toggle the phase noise mode by pressing **Utility** > **Opti. Φ Noise**> **Normal/ResFM Opt.**
- Save the current configures for your frequent use to either local memory or an external USB memory
- Connect and set an external reference by pressing **Utility** > **Ref Setups**
- Connect an external display monitor to the VGA connector for the education projects or other needs.

Enable an option

You are required to enter the option license key to enable the option. Contact your nearest Agilent Office for purchasing a license. Refer to the following steps to enable the I/Q modulator (option 001):

- 1 Press **Utility** hardkey
- 2 Press **License key** softkey
- 3 Enter the license and the option will be enabled immediately

Remote Control

The configuration of setting up a remote control for your N9310A is simply. You only need find a USB cable to connects your N9310A with a PC which has installed Agilent IO Libraries Suite.



If you need the remote control more flexible, you can also build up your own program by using Agilent VTL (Visa Transition Library) and the SCPI commands.

For more information about N9310A SCPI commands and programming examples, refer to “[Subsystem Command Reference](#)” on page 103.

For more information about Agilent IO Libraries Suite, refer to <http://www.agilent.com/find/iolib>

If you are new to instrument programming, please refer to [Chapter 5](#), “Programming Fundamentals,” starting on page 87.

Firmware Update

N9310A provides convenient firmware update service. Please refer to this procedure to finish the firmware update:

- 1 Download the firmware (ZIP file) from

<http://www.agilent.com/find/n9310a>

to your PC, refer to the flow chart for download:

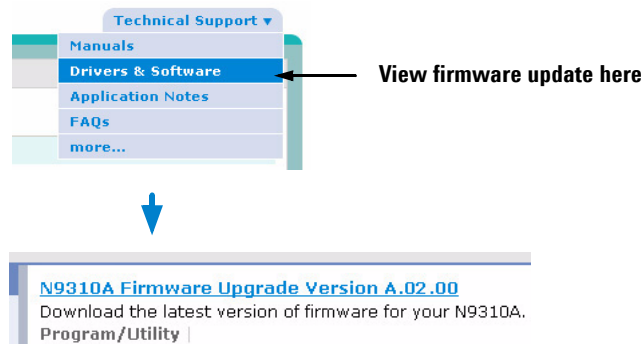

NOTE

The instrument firmware contains drivers for most of the USB memory sticks but not all. Please make sure your USB memory stick is in FAT16 or FAT 32 format. The N9310A doesn't support USB memory stick with self-startup partition or multi-partitions.

- 2 Extract the ZIP file, you will get the file *N9310A.update*, then copy this file into the root directory of your USB memory stick.
- 3 Power off your N9310A and insert this USB memory stick into the USB connector on the front panel.
- 4 Power on your N9310A, then press **[Enter]** to begin the upgrade process immediately.
- 5 The whole upgrade procedure will take several minutes. please wait until the instruction displayed before removing the USB memory stick. Then the instrument with new firmware is available for your current use after rebooting. Press **Utility** > **Information** to view the current firmware info.

Connectors Maintenance

Check the connectors at least every six months—more often if the instrument is used daily on a production line or in a harsh environment.

Visually inspect the front panel connectors. The most important connectors are those to which the DUT (device under test) is connected, typically the RF cable end or the RF OUT and LF OUT connectors. All connectors should be clean and the center pins centered. The fingers of female connectors should be unbroken and uniform in appearance. If you are unsure whether the connectors are good, gauge the RF OUT connectors to confirm that their dimensions are correct.

Maximum and minimum protrusion of center conductor from mating plane

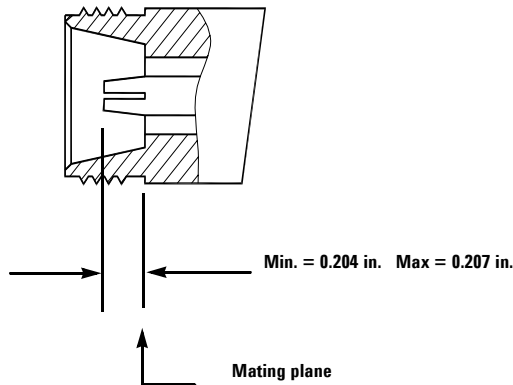



3 Using Functions

Commonly used Front-panel Elements	30
Generating a CW Signal	31
Generating a Step Swept Signal	32
Generating a List Swept Signal	39
Generating a Modulated Signal	41
Generating an LF Output	49
Save, Recall and Delete an Instrument State	50

This chapter contains procedures that show you how to use some of the major functions of your signal generator including setting frequency and power levels, setting up modulations, creating RF and LF sweeps, saving and recalling instrument states, and enabling options.

Commonly used Front-panel Elements

Besides using basic function hardkeys, you will be also busy with entering data and using softkeys. If you are new to N9310A, refer to the following tips on entering data and using softkeys.

Entering Data

When setting the value for a parameter, there are two ways of entering or modifying the value of the active function:

Using the numeric keypad and the unit softkey



- Numeric Keypad** Enters a specific value.
- Unit softkey** Terminates a data input via the numeric keypad

Using the knob, arrow keys and the Enter hardkey

- Knob** Increases or decreases the value or the value of each digit
- Arrow Keys** Set focus on the digit to be modified
- Enter** Confirms and terminates the data input

Using Softkeys

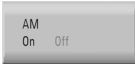
Softkeys, which appear along the right side of the display, provide access to many sub-functions. There are three types of softkeys being used in N9310A. See the table below to learn their types and functions.

Type	Function	Example
Toggle	Presses this types of softkeys toggles a parameter between two states	
Submenu	Presses this types of softkeys enters into a submenu	
Modify	Presses this types of softkeys enables you to modify the value of a parameter	

Generating a CW Signal

Generating a CW (Continuous Wave) signal requires you to set up the frequency and amplitude parameters and enable the RF output. The parameters has the following characters:

Character	Range	Default
Frequency	9 kHz to 3 GHz	3.0000000000 GHz, with 0.1 Hz resolution
Amplitude	-127 to +13 dBm (+20 dBm settable) -80 to +60 dBmV (+67 dBmV settable) -20 to +120 dBμV (+127 dBμV settable) 0.0001 to 1000 mV (2238.8 mV settable) 0.1 to 1000000 μV (2238800 μV settable)	-127 dBm, with 0.1 dB resolution

Operation Example

Assume you need to generate a CW signal with:

- a frequency of 700 MHz
- an amplitude of -20 dBm



Please refer to the following steps to set up the CW signal:

- 1 Press **Preset** hardkey
This returns the signal generator to the factory default state. To view the default settings of the signal generator, please check "[Factory Default Settings](#)" on page 70.

Observe the FREQUENCY and AMPLITUDE area of the display (in the upper left-hand corner). The value displayed is the maximum frequency (3 GHz) and the minimum amplitude (-127 dBm).
- 2 Press **Frequency** > **700** > **MHz** sets the CW frequency to 700 MHz.
- 3 Press **Amplitude** > **-20** > **dBm** sets the CW amplitude to -20 dBm.
- 4 Toggle **RF On/Off** hardkey to enable the RF output.

Generating a Step Swept Signal

The signal generator allows you to generate step swept signals in three modes:

Sweep Mode	Sweep Range	Front-panel key access
RF	9 kHz to 3 GHz	 > Sweep Mode > RF
Amplitude	-127 to +13 dBm	 > Sweep Mode > Ampl
LF	20 Hz to 80 kHz	 > Sweep Mode > LF

NOTE

During the swept RF output or Amplitude output, the FREQUENCY and AMPLITUDE area of the signal generator's display are deactivated, depending on which is being swept.

General Settings for a Step Sweep

Generally, you need to set up the following parameters for a step sweep:

- the start frequency/amplitude and stop frequency/amplitude
- a number of equally spaced points (steps) to dwell upon
- the amount of dwell time at each point

For an intuitive view of how to generate a step sweep, please refer to:

[“Generating an RF Sweep”](#) on page 35.

[“Generating an Amplitude Sweep”](#) on page 37.

[“Generating an LF Sweep”](#) on page 38.



Additional Settings for a Step Sweep

There are also other four setting items that have effects on the sweep:



- **Sweep Trigger**
You can set the sweep trigger to any of the following three choices: **Immediate/Trigger Key/EXT**
- **Point Trigger:**
You can set the point trigger to any of the following three choices: **Immediate/Trigger Key/EXT**
- **Sweep Repeat: Cont/Single**
You can set the sweep repeat to either **Cont** or **Single**.
If set to **Cont**, the signal generator sweeps from the start point to the stop point and cycles continuously.
If set to **Single**, the signal generator sweeps from the start point to the stop point for only one circle.
- **Sweep Direction: Up/Down**

Take RF sweep for example, as you enable RF sweep by pressing

 > **Sweep Mode** > **RF**, the signal generator performs as below, according to combinatorial settings of sweep trigger and point trigger.

Sweep Trigger	Point Trigger	Sweep Performance
IMM	IMM	Pressing  > Sweep mode > RF initiates sweeping immediately and automatically. Pressing  > Sweep mode > Off closes the sweep.
IMM	Key	Pressing  > Sweep mode > RF enables the RF sweep, then pressing the Trigger key initiates sweeping over the points manually.

3 Using Functions

Sweep Trigger	Point Trigger	Sweep Performance
Key	IMM	Pressing  > Sweep mode > RF , the "ARMED" annunciator displays on the screen, indicating the signal generator is ready and waits for your trigger instruction. Pressing Trigger key initiates the signal generator sweeping over the points automatically.
Key	Key	Pressing  > Sweep mode > RF , the "ARMED" annunciator displays on the screen, indicating the sweep is ready and wait for your trigger. Pressing  > Sweep mode > RF enables the RF sweep, then pressing the Trigger key initiates sweeping over the points manually.

If you want to use an external trigger source, a TTL signal with 100 ns as the minimum level holding time is required. Only when the sweep trigger is set to **Key** and the point trigger is set to **EXT**, is the sweep repeat able to set to either **Single** or **Cont**. The other combinations of the sweep trigger and point triggers allows continuous sweep only.

Generating an RF Sweep

Assume you are going to generate an RF sweep with the following settings:

- frequency range from 1 GHz to 2 GHz, at a level of 0 dBm
- nine sweep points and 50 ms dwell time at each point

Refer to the following procedures to configure and generate an RF sweep:

- 1 Press **Preset** hardkey
- 2 Press **Amplitude** > **0** > **dBm**
This step sets the RF sweep output level at 0 dBm.
- 3 Press **Sweep** hardkey
This step opens the sweep submenus.
- 4 Press **Step Sweep** softkey
This step opens a submenu for step sweep configurations.
- 5 Press **RF Start** > **1** > **GHz**
This step sets the start frequency of the sweep to 1 GHz.
- 6 Press **RF Stop** > **2** > **GHz**
This step sets the stop frequency of the sweep to 2 GHz.
- 7 Press **# Points** > **9** > **Enter**
This step sets the number of sweep points to nine.
- 8 Press **More(1/2)** > **Step Dwell** > **50** > **ms**
This step sets the dwell time at each point to 50 ms.
- 9 Press **RF On/Off** hardkey to enable the RF output.
The annunciator changes from **RF OFF** to **RF ON**.

10 Press **Return > Sweep Mode > RF**

This step enables the RF sweep and initiates the signal generator to sweep immediately and automatically. A **SWEEP** annunciator displays for the duration of the sweep.

NOTE

The signal generator defaults the sweep trigger and point trigger settings to **Immediate** as you preset the instrument. For more information about how to use different trigger modes, please refer to [“Additional Settings for a Step Sweep”](#) on page 33.

For more information about the sweep settings, please refer to [“Sweep”](#) on page 73.

Generating an Amplitude Sweep

Assume you are going to generate an amplitude sweep with the following settings:

- amplitude ranges from -80 to -60 dBm, at a frequency of 1 GHz
- 9 sweep points and 50 ms dwell time at each point

Refer to the following steps to configure and generate an amplitude sweep:

- 1 Press **Preset** hardkey
- 2 Press **Frequency** > **1** > **GHz**
- 3 Press **Sweep** hardkey
- 4 Press **Step Sweep** softkey
- 5 Press **# Points** > **9** > **Enter**
- 6 Press **More** > **Ampl Stop** > **-60** > **dBm**
- 7 Press **Ampl Stop** > **-80** > **dBm**
- 8 Press **Step Dwell** > **50** > **ms**
- 9 Press **RF On/Off** hardkey to enable the RF output.
- 10 Press **Return** > **Sweep Mode** > **Ampl** to enable the amplitude sweep immediately. A **SWEEP** annunciator displays for the duration of the sweep.

For more information about the sweep settings, please refer to “Sweep” on page 73.

Generating an LF Sweep

Assume you are going to generate an LF sweep with the following settings:

- frequency range from 10 to 60 kHz, at a level of 500 mV
- six sweep points and 50 ms dwell time at each point

NOTE

Pressing **Preset** sets the sweep/point trigger to Immediate and the LF output amplitude to 500 mV. The following procedures leave out the steps that set up the sweep/point trigger and the LF output amplitude.

Refer to the following procedures to configure and generate an LF sweep:



- 1 Press **Preset** hardkey
- 2 Press **Sweep** hardkey
- 3 Press **Step Sweep** softkey
- 4 Press **LF Start > 10 > kHz**
- 5 Press **LF Stop > 60 > kHz**
- 6 Press **# Points > 6 > Enter**
- 7 Press **Step Dwell > 50 > ms**
- 8 Press **Return > Sweep State > LF**
This initiates the LF sweep output immediately via the LF OUT connector. A **SWEEP** annunciator displays for the duration of the sweep.

For more information about the sweep settings, please refer to “Sweep” on page 73.

Generating a List Swept Signal

List sweep allows you to create a list of arbitrary frequency, amplitude, and dwell time values and sweep the output based on the entries in the **List Mode Values** table.

This signal generator allows you to generate list swept signals in three modes:

Sweep Mode	Sweep Range	Front-panel key access
RF	9 kHz to 3 GHz	 > Sweep Mode > RF
Amplitude	-127 to +13 dBm	 > Sweep Mode > Ampl
RF&Ampl	9 kHz to 3GHz &-127 to +13 dBm	 > Sweep Mode > RF&Ampl

Unlike a step sweep that contains linear ascending/descending frequency and amplitude values spaced at equal intervals throughout the sweep, list sweep frequencies and amplitudes can be entered at unequal intervals, nonlinear ascending/descending, or random order.

In fact both the RF mode and the Amplitude mode in list sweep are quite similar to their counterparts in step sweep, except the differences stated in the above descriptions. Thus we will only discuss some detail operational procedures for **RF&Ampl**, which could also be referenced when you are using the **RF mode** or the **Amplitude mode**, just notice that in the RF mode all signals share the same amplitude while in the Amplitude mode all signals share the same frequency.

Now refer to the following procedures to configure and generate an RF&Ampl sweep:

- 1 Press **Preset** hardkey
- 2 Press **Sweep** > **Sweep Type** > **List**.
- 3 Press **List Sweep**> **Insert Row** to input your list sequence.
- 4 Using the knob to highlight the item that you want to edit, input the corresponding value and end it with a unit key.
- 5 Press **Return** to go back to the upper level menu when you have finished inputting all the values for your testing sequence.
- 6 Press **More(1/2)** softkey, go to the next menu
- 7 Press **Sweep Trigger** > **Trigger Key**
- 8 Press **Point Trigger** > **Immediate**
- 9 Press **More(2/2)** softkey, go back to the previous menu
- 10 Press **Sweep Mode** > **RF & Ampl**
- 11 Press **RF On/Off** hardkey to enable the RF output.
- 12 Press the **Trigger** hardkey on the front panel

This step enables the list sweep and initiates the signal generator to sweep both frequency and amplitude immediately and automatically.

NOTE

The signal generator defaults the sweep trigger and point trigger settings to **Immediate** as you preset the instrument. For more information about how to use different trigger modes and how to set **Sweep Direction** and **Sweep Repeat**, please refer to “[Additional Settings for a Step Sweep](#)” on page 33. It works the same way when you are setting these modes in a list sweep.

Generating a Modulated Signal



The signal generator allows you to generate the following modulated signals: AM, FM, Φ M, Pulse Modulation. An optional I/Q modulator is also available when you installed *Option 001* on the signal generator.

Preparing the Modulation Format

You can turn on the modulation format prior to or after setting the other modulation parameters. Perform the following steps to turn the modulation format on and output a modulated signal:

- 1 Access the submenu a modulation format. For example, **AM**.

This submenu shows a set of softkeys associated with the format's name. For example, AM Depth, AM Source.

- 2 Press the  hardkey until **MOD ON** is displayed. And press  key to enable the RF output.



More intuitive examples on generating a modulated signal come in the following pages.

Simultaneous Modulations

The signal generator also allows you to generate more than one modulation formats simultaneously. Refer to the following table to generate the simultaneous modulations.

	AM (INT)	AM (EXT)	I/Q	FM (INT)	FM (EXT)	FM	Pulse (INT)	Pulse (EXT)
AM (INT)	–	•	–	•	•	•	–	–
AM (EXT)	•	–	–	•	•	•	–	–
I/Q	–	–	–	•	•	•	•	•
FM (INT)	•	•	•	–	•	–	•	•
FM (EXT)	•	•	•	–	–	–	•	•
FM	•	•	•	–	–	–	•	•
Pulse (INT)	–	–	•	•	•	•	–	–
Pulse (EXT)	–	–	•	•	•	•	–	–

Generating an AM signal

The signal generator generates AM (amplitude modulated) signals with the following basic settings:





Character	Range	Default
AM Depth	0.0 to 100.0 %	0.0
AM Source	Internal source (INT) External source (EXT) Combined INT and EXT	INT
AM Rate	20 Hz to 80 kHz (INT) DC/20 Hz to 80 kHz (EXT)	1.0000 kHz, 0.1 Hz resolution

Operation Example

Assume that you are going to generate an AM signal with:

- Carrier frequency of 1 GHz, amplitude of -10 dBm
- AM depth of 70 %
- AM rate at 15 kHz
- Internal AM source (default by )

Refer to the following to configure your signal generator:

- 1 Pressing  presets the signal generator
- 2 Pressing  > **1** > **GHz** sets the CW frequency to 1 GHz
- 3 Pressing  > **-10** > **dBm** sets the CW amplitude to -10 dBm
- 4 Pressing  enters the AM submenu
- 5 Pressing **AM Depth** > **70** > % sets AM depth to 70 %
- 6 Pressing **AM Rate** > **15** > **kHz** sets AM rate to 15 kHz
- 7 Pressing **AM On** enables AM
- 8 Pressing  **On** enables the AM signal output

For key reference, please refer to “AM” on page 54.

Generating an FM Signal

The signal generator generates FM (frequency modulated) signals with the following basic settings:





Character	Range	Default
FM Deviation	20 Hz to 100 kHz	20 Hz, 1 Hz resolution
FM Source	Internal source (INT) External source (EXT) Combined INT and EXT	INT
FM Rate	20 Hz to 80 kHz (INT) DC/20 Hz to 80 kHz (EXT)	1.0000 kHz, 0.1 Hz resolution

Operation Example

Assume that you are going to generate an FM signal with:

- Carrier frequency of 1 GHz, amplitude of -10 dBm
- FM deviation of 50 kHz
- FM rate at 30 kHz
- Internal FM source (default by )

Refer to the following to configure your signal generator:

- 1 Pressing  presets the signal generator
- 2 Pressing  > **1** > **GHz** sets the CW frequency to 1 GHz
- 3 Pressing  > **-10** > **dBm** sets the CW amplitude to -10 dBm
- 4 Pressing  enters the FM submenu
- 5 Pressing **FM Deviation** > **50** > **kHz** sets FM deviation to 50 kHz
- 6 Pressing **FM Rate** > **30** > **kHz** sets FM rate to 30 kHz
- 7 Pressing **FM** > **On** enables FM
- 8 Pressing  hardkey to **RF On** enables FM signal output.

For key reference, please refer to “FM” on page 61.

Generating a Phase Modulated Signal

The signal generator generates phase modulated (Φ M) signals with the following basic characters:

Character	Range	Default
Φ M Deviation	0 to 10 rad ($300 \text{ Hz} \leq \Phi\text{M rate} \leq 10 \text{ kHz}$) 0 to 5 rad ($10 \text{ kHz} < \Phi\text{M rate} \leq 80 \text{ kHz}$)	0.000 rad, with 0.001 rad resolution
Φ M Source	Internal source only	N/A
Φ M Rate	300 Hz to 80 kHz	1.0000 kHz, with 0.1 Hz resolution

Operation Example

Assume that you are going to generate a Φ M signal with the following characters:

- Carrier frequency of 1 GHz, amplitude of -10 dBm
- Φ M deviation of 7.3 rad
- Φ M rate at 10 kHz

Refer to the following to configure your signal generator:

- 1 Pressing **Preset** presets the signal generator
- 2 Pressing **Frequency** > **1** > **GHz** sets the CW frequency to 1 GHz
- 3 Pressing **Amplitude** > **-10** > **dBm** sets the CW amplitude to -10 dBm
- 4 Pressing **Φ M** enters the Φ M submenu
- 5 Pressing **Φ M Deviation** > **7.3** > **rad** sets Φ M deviation to 7.3 rad
- 6 Pressing **Φ M Rate** > **10** > **kHz** sets Φ M rate to 10 kHz
- 7 Pressing **Φ M On off** enables Φ M
- 8 Pressing **RF On/Off** to **On** enables Φ M signal output.

For key reference, please refer to “Phase Modulation” on page 67.

Generating a Pulse Modulated Signal

The signal generator generates pulse modulated signals with the following characters:

Character	Range	Default
Pulse Source	Internal source (INT) External source (EXT)	INT
Pulse Period	200 μ s to 2 s (INT and EXT)	200 μ s, with 1 μ s resolution
Pulse Width	100 μ s to 1 s (INT and EXT)	100 μ s, with 1 μ s resolution

Operation Example

Assume that you are going to generate an pulse modulated signal with the following characters:

- Carrier frequency of 1 GHz, amplitude of -10 dBm
- Pulse period of 10 ms
- Pulse width of 6 ms
- Internal pulse source (default by **Preset**)

Refer to the following to configure your signal generator:

- 1 Pressing **Preset** presets the signal generator
- 2 Pressing **Frequency** > **1** > **GHz** sets the CW frequency to 1 GHz
- 3 Pressing **Amplitude** > **-10** > **dBm** sets the CW amplitude to -10 dBm
- 4 Pressing **Pulse** enters the Pulse modulation submenu
- 5 Pressing **Pulse Period** > **10** > **ms** sets pulse period to 10 ms
- 6 Pressing **Pulse width** > **6** > **ms** sets pulse width to 6 ms
- 7 Pressing **Pulse On/Off** enables pulse modulation
- 8 Pressing **RF On/Off** **On** enables pulse modulated signal output

For key reference, please refer to “Pulse” on page 71.

Generating an I/Q Modulated Signal (Option 001 Only)

The signal generator generates I/Q modulated signals with the following basic characters:

Character	Range	Default
I/Q Source	External source only	N/A
I/Q Input	50 Ω impedance VSWR < 1.5 Full scale input < 0.5 Vrms	N/A
I/Q Input Connector	EXT I and Q connector on rear panel (BNC type, female)	N/A

If you use a constant sum vector modulation of $\sqrt{I^2 + Q^2} = 0.5$ V to drive the I/Q modulator, the actual RF level corresponds to the displayed RF level. To avoid overdriving the I/Q modulator, you must take care that the sum vector never exceed 0.5 V when using I/Q modulation. For full-scale input, the peak envelope power of the modulated RF signal is thus equal to the indicated LEVEL. The average power is smaller.

$$\text{Amplitude} = \frac{\sqrt{I^2 + Q^2}}{0.5V} \text{ input value LEVEL}$$

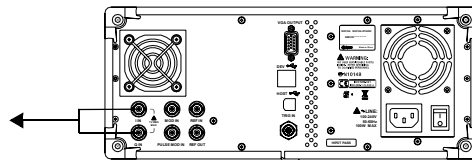
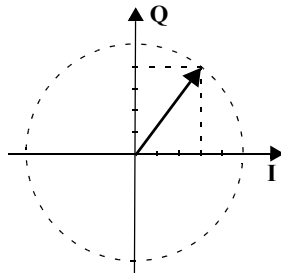

Operation Example

Assume that you are going to generate an I/Q modulated signal with 1 GHz carrier frequency, amplitude of -10 dBm

Refer to the following procedures to configure and generate an I/Q modulated signal:

- 1 Connecting the external I/Q source to the BNC I and Q connectors on the rear panel of the signal generator
- 2 Pressing **Preset** presets the signal generator
- 3 Pressing **Frequency** > **1** > **GHz** sets the CW frequency to 1 GHz
- 4 Pressing **Amplitude** > **-10** > **dBm** sets the CW amplitude to -10 dBm
- 5 Pressing **I/Q** enters the I/Q modulation submenu
- 6 Pressing **I/Q On/Off** enables I/Q modulation
- 7 Pressing **RF On/Off** enables I/Q modulated signal output

Generating an LF Output

The signal generator allows you to generate an LF (Low Frequency) signal with the following characters. Low frequency signal is also usually called audio frequency.

Character	Range	Default
Frequency	20 Hz to 80 kHz	1.0000 kHz, with 0.1 Hz resolution
Amplitude	0 to 3 V (peak)	500 mV, with 1 mV resolution
Output Connection	LF OUT connector on the front panel (BNC type, 50 Ω)	N/A

Operation Example

Assume you are going to generate an LF signal with:

- a frequency of 10 kHz
- an amplitude of 3 V

Refer to the following steps to generate the LF signal:

- 1 Pressing **LF Out** enters submenu of LF output function.
- 2 Pressing **LF Out Freq > 10 > kHz** sets LF frequency to 10 kHz
- 3 Pressing **LF Out Ampl > 3 > V** sets LF amplitude to 3 V
- 4 Pressing **LF Out On/Off** to **On** state enables LF output.

Save, Recall and Delete an Instrument State

The signal generator allows you to save instrument states either in local memory or to an external USB memory stick in a format of a configuration file (*.cfg). You can also recall those states from the local memory or an external flash memory for a quick start of commonly used instrument states or some particular applications' configurations.

NOTE

Before you unplug a USB memory stick from the USB connector on the front or rear panel of the signal generator, you are recommended to set the file catalog to **Local** first.

Saving an Instrument State

All the instrument states are saved in the file format of “<file name>.cfg” , such as “sample.cfg”.

The file name can be modified with the 26 lowercase letters from a to z and 10 arabic numbers from 0 to 9.

The signal generator provides up to 20 files memory spaces in the local memory.

Saving an instrument state in the local memory

Refer to the following steps to save an instrument state in the local memory:

- 1 Pressing **File** > **Catalog** > **Local** sets file catalog to local memory
- 2 Pressing **Save** softkey enables editing a file name for the instrument state you are going to save
- 3 Edit the file name by rotating the knob and pressing **Next** softkey for entering each letter or number
- 4 Pressing **Save now** softkey confirms the file name and saves the instrument state into local memory immediately

See the example on the next page for how to editing the file name.

How to edit a file name Assume you need to name an instrument state as “sample”, refer to following operations:

- 1 Pressing **Save** softkey enables editing file name and the signal generator automatically types an “a” as the first letter.
- 2 Rotating the knob until the first letter changes to “s”.
- 3 Press **Next** softkey to confirm the first letter and the signal generator automatically types an “a” as the second letter.
- 4 Repeat step 2 and step 3, until editing the file name “sample” completes.
- 5 Pressing **Save now** confirms the file name and saves the instrument state named as “sample.cfg” immediately in the local memory.

Saving an instrument state to an external USB memory stick

Refer to the following steps to save an instrument state into a USB memory stick:

- 1 Pressing **Catalog > USB** sets the file catalog to **USB**.
- 2 Pressing **Save** softkey enables editing file name for the instrument state you are going to save.
- 3 Edit the file name by rotating the knob and pressing **Next** softkey for entering next letter.
- 4 Press **Save now** softkey to confirm the file name and save the instrument state into the external USB memory stick immediately.

Recalling an Instrument State

The signal generator allows you to recall an instrument state from either the local memory or an external USB memory stick.

Recalling an instrument state from the local memory

Refer to the following steps to recall an instrument state from the local memory:

- 1 Set file catalog to **Local** (default)
- 2 Rotate the knob to choose a file
- 3 Press the **Recall** softkey to recall the file immediately

Recalling an instrument state from an external flash memory

Refer to the following steps to recall an instrument state from the local memory:

- 1 Set file catalog to **USB**
- 2 Rotate the knob to choose a file
- 3 Press the **Recall now** softkey to recall the file immediately.

Delete an Instrument State

Refer to the following steps to delete an instrument state from the local memory:

- 1 Set file catalog to **Local** or **USB**
- 2 Rotate the knob to choose a file
- 3 Press the **Delete** softkey
- 4 Press the **Delete now** softkey to confirm and delete the file immediately

NOTE

It is impossible to recover files after pressing **Delete now**. If you change your mind and do not wish to delete the files, press **Return** softkey instead.



4 Key Reference

This chapter describes each front panel hardkey and associated softkeys, as well as the default value for each key. The chapter is organized alphabetically by front panel hardkey. Each section arranges the softkey description logically.





AM



Pressing **AM** reveals a submenu for AM configurations.

AM On/Off	Toggles amplitude modulation state between on and off
AM Depth	Sets amplitude modulation depth
AM Source ▶	Enters amplitude modulation source submenu:
INT	Selects internal AM source
EXT	Selects external AM source
INT+EXT	Selects internal and external AM source
AM Rate	Sets amplitude modulation frequency
AM Waveform	Selects amplitude modulation waveform
Sine	Selects sine amplitude modulation waveform
EXT Coupling AC/DC	Toggles external coupling between AC and DC

AM On Off Pressing this softkey toggles the amplitude modulation between on and off. A **AM** annunciator will display on the screen after you enable AM. However, the amplitude modulation will be processed only when you also turn the modulation on by pressing the **Mod On/Off** hardkey.

- Default value: **Off**
- Key sequence: **AM** > **AM On Off**

- AM Depth** Pressing this softkey enters the value of AM depth. The active entry area displays the current value of AM depth. The AM Depth ranges from 0 % to 100 %, with minimum increment of 0.1 %.
- Default value: **0.0 %**
 - Key sequence:  > **AM Depth**
- AM Source** Pressing this softkey reveals a menu of choices for amplitude modulation sources. It allows you to select an internal source or an external source from MOD IN connector, or select internal and external simultaneously.
- Pressing **INT** connects an internally calibrated signal to the modulator. This internal AM source defaults to a sine wave at a frequency of 1.0000 kHz.
- Pressing **EXT** connects an externally calibrated signal to the modulator. You need also set the **EXT Coupling**, see “[Ext Coupling](#)” on next page.
- Pressing **INT+EXT** connects both an internally calibrated signal and an externally calibrated signal to the modulator simultaneously.
- Default value: **INT**
 - Key sequence:  > **AM Source**
- AM Rate** Pressing this softkey modifies the internal modulation frequency. The active entry area displays the current value of AM rate. The allowed value range is 20 Hz to 80 kHz. The minimum increment is 0.1 Hz. when external AM source is selected, this softkey is disabled.
- Default value: **1 kHz**
 - Key sequence:  > **AM Rate**

- AM Waveform** Pressing this softkey reveals a menu of modulating signal waveform choice.
- Default value: **Sine**
 - Key sequence:  > **AM waveform**
- Ext Coupling** Pressing this softkey toggles external modulating signal input either in AC (Alternating Current) or DC (Direct Current) coupling.
- Selecting **AC** isolates the DC component in the signal and only passes by AC component into the modulator. The Amplitude will go down without DC component.
- Selecting **DC** allows an integrated external signal with both DC and AC component. A 1.0 V_{peak} ± 2 % input level is required.
- Default value: **AC**
 - Key sequence:  > **EXT Coupling**

Amplitude

Pressing  hardkey allows you to modify the RF output power level. Amplitude becomes the active function and the active entry area of the display shows the current value.

The calibrated power range is -127 to 13 dBm (+20 dBm settable). The minimum increment allowed is 0.1 dB. The amplitude area of the display always shows the current RF output power except when an amplitude sweep is in process.

- Default value: **-127.0 dBm**

It also allows you to modify the RF output power level using the following scales:

Range	Minimum increment
-127.0 to $+13.0$ dBm, (max. $+20$ dBm settable)	0.1 dB
-80.0 to $+60.0$ dBmV, (max. $+67$ dBmV settable)	0.1 dB
-20.0 to $+120.0$ dB μ V, (max. $+127$ dB μ V settable)	0.1 dB
0.0001 to 1000.0 mV, (max. 2238.8 mV settable)	0.1 mV
0.1 to 1000000.0 μ V, (max. 2238800 μ V settable)	0.1 μ V (Ampl ≤ 999.9 μ V) 100 μ V (Ampl ≥ 1000.0 μ V)

Arrow Keys



Pressing the left/right arrow keys allows you to modify a data digit by digit, together with rotating the knob. You also need pressing  hardkey to confirm the data modification.

For example, if you wish to modify 2.000 000 0000 GHz to 2.000 000 0500 GHz, please follow these steps:

- 1 pressing the left/right arrow key shift the focus to the digit
- 2 rotating the knob until “5” displays
- 3 Pressing  hardkey to confirm your modification





Enter

There are two usages of the  hardkey.

- 1 Confirming data modification. Using Enter hardkey together with arrow keys or knob when modifying a data. See the usage in **Arrow Key** on the same page.
- 2 Initiating a single sweep. Take an RF single sweep for example, pressing  > **Sweep Mode** > **RF** initiates the first run of a single RF sweep, then the sweep hangs up for an instruction to run again. Pressing  hardkey at this moment instructs the instrument to run another cycle of the single RF sweep again.

File

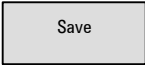
Pressing  hardkey reveals a submenu for saving, or recalling or deleting a customized configuration file. For how to do with a file, you can also refer to “[Save, Recall and Delete an Instrument State](#)” on page 50.

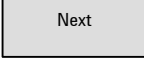
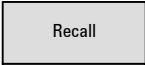
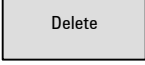
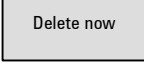
	Accesses the File Catalog submenus
	Selects local memory as the current catalog
	Selects USB device as the current catalog
	Enables editing a file name and saving a file
	Saves a file to the current catalog
	Goes to edit next letter/number
	Recalls a file from the current catalog
	Deletes a file from the current catalog
	Confirms deleting

Catalog Pressing this softkey selects the catalog for storing configuration files. **Local** means saving a configuration file in the instrument’s internal memory. **USB** means saving a configuration file in a peripheral USB memory stick via the USB device connector.

Insert the external memory stick into the USB connector (device) first, then the signal generator detects the USB memory stick as soon as you set the catalog to **USB**.

- Default value: **Local**
- Key sequence:  > **Catalog**

- Save** Pressing **Save** softkey enables you to save the current instrument status into a file and also edit a file name for the file. You can save maximum 20 files in the local memory. Pressing **Preset** hardkey or conducting a power cycle does not affect the customized configuration file in the local memory. See “[Saving an Instrument State](#)” on page 50 on editing a file name by using **Save**, **Save now** and **Next** softkeys.
- Softkey sequence: **File** > **Save**

- Recall** Pressing **Recall** softkey recalls a customized configuration file that you have selected by scrolling the knob.
- Before you press this softkey to recall a file from external USB memory stick, make sure the file you need is in the root directory of the USB memory stick.
- Softkey sequence: **File** > **Recall**

- Delete** Pressing **Delete** softkey enables you to delete a configuration file that you have selected by rotating the knob. Pressing **Delete now** confirms deleting.
- Softkey sequence: **File** > **Delete**



CAUTION

Do NOT press **Delete now** before you make sure the selected file is the one you do not need any more.

FM

Pressing  hardkey reveals a submenu for FM configurations.

FM On/Off	Toggles frequency modulation between on and off						
FM Deviation	Sets frequency modulation deviation						
FM Source ▶	Enters frequency modulation source submenu:						
	<table border="1"> <tbody> <tr> <td>INT</td> <td>Selects internal FM source</td> </tr> <tr> <td>EXT</td> <td>Selects external FM source</td> </tr> <tr> <td>INT+EXT</td> <td>Selects internal and external FM source</td> </tr> </tbody> </table>	INT	Selects internal FM source	EXT	Selects external FM source	INT+EXT	Selects internal and external FM source
INT	Selects internal FM source						
EXT	Selects external FM source						
INT+EXT	Selects internal and external FM source						
FM Rate	Sets frequency modulation rate						
FM Waveform	Selects frequency modulation waveform						
	<table border="1"> <tbody> <tr> <td>Sine</td> <td>Selects sine frequency modulation waveform</td> </tr> </tbody> </table>	Sine	Selects sine frequency modulation waveform				
Sine	Selects sine frequency modulation waveform						
EXT Coupling AC/DC	Toggles external coupling between AC and DC						

FM On Off This softkey toggles the frequency modulation between on and off. When press this softkey on, the FM annunciator is turned on in the display. Although pressing this softkey enables the FM, it is applied to the RF carrier only after you also enable the modulator by pressing  and the  displays.

- Default value: **Off**
- Key sequence:  > **FM On Off**

FM Deviation Pressing this softkey sets the frequency modulation deviation. The active entry area shows the current FM deviation. The allowed values range is 20 Hz to 100 kHz. The minimum increment is 0.1 Hz.

- Default value: **20 Hz**
- Key sequence:  > **FM Deviation**

FM Source Pressing this softkey reveals a menu for Frequency modulation sources selection. It allows you to select an internal FM source or an external FM source from MOD IN connector, or select internal and external simultaneously.

Pressing **INT** connects an internally generated, calibrated signal to the modulator. This internal FM source defaults to a sine wave at a frequency of 1.0000 kHz.



Pressing **EXT** connects an externally calibrated signal to the modulator. You need also set the **EXT Coupling**, see “[EXT Coupling](#)” on next page.

Pressing **INT+EXT** connects both an internally calibrated signal and an externally calibrated signal to the modulator simultaneously.

- Default value: **INT**
- Key sequence:  > **FM Source**

FM Rate Pressing this softkey allows you to enter the frequency of internal modulation source. The active entry area displays the current FM rate. The allowed value range is 20 Hz to 80 kHz. The minimum increment is 0.1 Hz. When external FM source is selected, this softkey is disabled.

- Default value: **1.0000 kHz**
- Key sequence:  > **FM Rate**

- FM Waveform** Pressing this softkey reveals a submenu of FM waveform choices.
- Default value: **Sine**
 - Key sequence:  > **FM Waveform**
- EXT Coupling** Pressing this softkey toggles external modulating signal input in either AC or DC coupling. A $1.0 V_{\text{peak}} \pm 2\%$ input level is required.
- Selecting **AC** isolates the DC component in the signal, there is only AC component in the applied signal. The amplitude will go down without DC component.
- Selecting **DC** allows an integrated external signal with both DC and AC component entering to the modulator of the signal generator.
- Default value: **AC**
 - Key sequence:  > **EXT Coupling**

Frequency

Pressing  hardkey allows you to modify the RF output frequency. Frequency becomes the active function and the active entry area displays the current value.

The allowed frequency range is 9 kHz to 3 GHz. The minimum increment is 0.1 Hz. The frequency area always shows the current CW output frequency except when an RF sweep is in process.

- Default value: **3 GHz**

I/Q (Option 001 only)

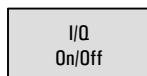

Switches I/Q modulation on/off



I/Q This softkey toggles the external I/Q modulation state
On Off between on and off. Whenever I/Q modulation is enabled, the I/Q annunciator displays on the screen.

- Default value: **Off**
- Key sequence: **I/Q > I/Q On Off**

LF Out

Pressing  hardkey reveals a submenu of softkeys to configure the internal LF (low frequency) generator.

LF Out On/Off	Toggles LF output between on and off
LF Out Freq	Sets LF frequency
LF Out Ampl	Sets LF output amplitude

LF Out On/Off This softkey toggles the LF output between on and off. Once you have set the output on, the signal is available at the LF OUT connector. The  and  hardkeys do not apply to this state.

- Default value: **Off**
- Key sequence:  > **LF On/Off**

LF Out Freq Pressing this softkey sets the frequency of the LF signal. The active entry area displays the current LF signal frequency. The allowed frequency range is 20 Hz to 80 kHz.

- Default value: **1.0000 kHz**
- Key sequence:  > **LF Out Freq**

LF Out Ampl Pressing this softkey sets the amplitude of the LF signal. The active entry area displays the current LF signal amplitude. The allowed amplitude range is 0 to 3 V_{peak}, with 1 mV minimum increment.

- Default value: **500 mV**
- Key sequence:  > **LF Out Ampl**

Mod On/Off

Toggle this hardkey **On** to modulate the RF carrier with the active modulation.

An **Mod On/Off** annunciator is always turned on in the display to indicate whether modulation is on or off.

After pressing  hardkey, a  annunciator will display on the screen which indicates the modulator is active.

- Default value: **Mod On**

RF On/Off

Pressing this hardkey toggles the RF out between on and off. An annunciator is always in the display to indicate whether RF is on or off.

Default Value: **RF Off**

Numeric Keypad

The numeric keypad consists of digit keys (0 to 9), a decimal point key, and a backspace key. The backspace key has dual functions for backspacing and changing the sign of a value to positive or negative. Use these keys at any time when an active function requires a value input.



The backspace key function changes according to the situations below:

- When modifying a previously entered value, pressing the backspace key deletes the entire value and leaves the negative sign. Subsequent key presses change the sign between positive and negative states.
- When entering a new value, pressing the backspace key deletes the digit immediately to the left. When no digit remains, subsequent key presses change the sign between positive and negative states.

Phase Modulation

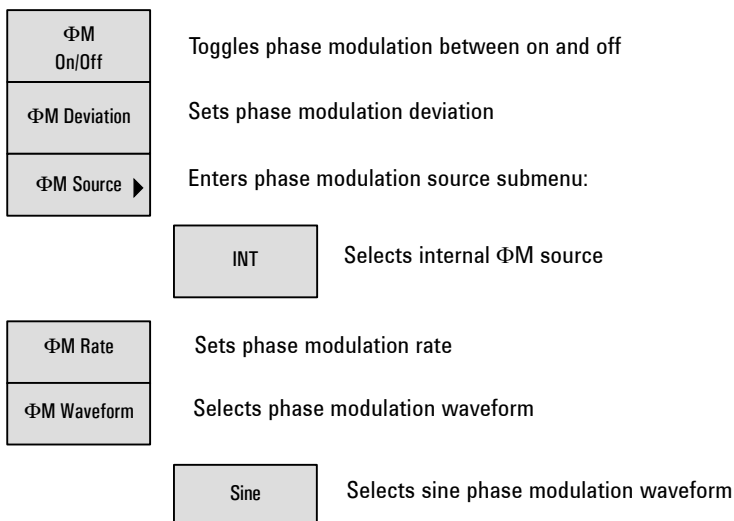
Pressing the  hardkey reveals a submenu of softkeys for phase modulation configurations.



ΦM On Off Pressing this softkey toggles the phase modulation between on and off. Whenever phase modulation is enabled, the ΦM annunciator is turned on in the display. However, it is applied to the RF carrier only after you also enable the modulator by pressing  hardkey and the  annunciator displays.

- Default value: **Off**
- Key sequence:  > **ΦM On/Off**

ΦM Deviation Pressing this softkey sets the phase modulation deviation. The active entry area displays current ΦM deviation value. The allowed value ranges according to the ΦM rate:
 0 to 10 rad ($300 \text{ Hz} \leq \Phi\text{M rate} \leq 10 \text{ kHz}$)
 0 to 5 rad ($10 \text{ kHz} < \Phi\text{M rate} \leq 80 \text{ kHz}$)

- Default value: **0.000 rad**
- Key sequence:  > **ΦM Deviation**

Φ M Source Pressing this softkey chooses a phase modulation source.

- Default value: **INT**
- Key sequence:  > **Φ M Source**

Φ M Rate Pressing this softkey modifies the internal modulation frequency. The active entry area displays the current value of Φ M rate. The allowed values range is 300 Hz to 80 kHz. The minimum increment is 0.1 Hz. when external Φ M source is selected, this softkey is disabled.

- Default value: **1.0000 kHz**
- Key sequence:  > **Φ M Rate**

Φ M Waveform Pressing this softkey reveals a submenu of Φ M waveform choices.

- Default value: **Sine**
- Key sequence:  > **Φ M Waveform**

Switch

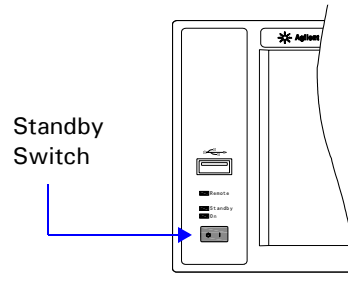

Pressing this front panel switch toggles power to the signal generator between on (green LED on) and standby (orange LED on). In standby mode, the signal generator is switched off, but the instrument is still connected to the line power. The rear panel line switch and the detachable power cord is the instrument disconnecting device. The front panel power switch, therefore, is not, and should not be used as a power switch.

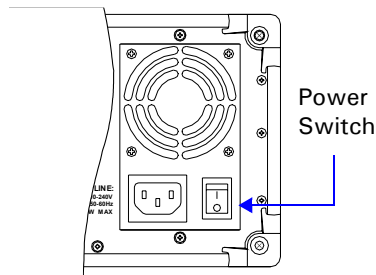

CAUTION

Avoid turning off power to the signal generator when current state is changing as a result of front panel operation or remote control.

Preset

Pressing **Preset** hardkey sets the signal generator to a factory default state. Pressing this hardkey does not clear the customized configuration files.



Factory Default Settings

Item	Default	Item	Default
Frequency	3.000 000 0000 GHz	Sweep Scale	Linear
Amplitude	-127.0 dBm	Sweep/Point Trigger	Immediate
LF Out	Off	Sweep Direction	Up
LF Out Freq	1.0000 kHz	Trig In Polarity	Negative
LF Out Ampl	500 mV	Modulation	
Mod ON/OFF	On	Modulation State	Off
RF ON/OFF	Off	AM Depth	0.0 %
Sweep		Φ M Deviation	0.000 rad
Sweep Mode	Off	FM Deviation	20 Hz
RF Start	9.0000 kHz	Pulse Period	200 μ s
RF Stop	3.000 000 0000 GHz	Pulse Width	100 μ s
Amplitude Start	-127.0 dBm	Modulation Source	INT
Amplitude Stop	-126.0 dBm	Modulation Rate	1.0000 kHz
LF Start	20.0 Hz	Ext Coupling	AC
LF Stop	80.0000 kHz	System	
#Point	10	File Catalog	Local
Step Dwell	10.0 ms	Opt. Φ Noise	Normal
Sweep Repeat	Cont	Reference Source	Int_10 MHz

Pulse

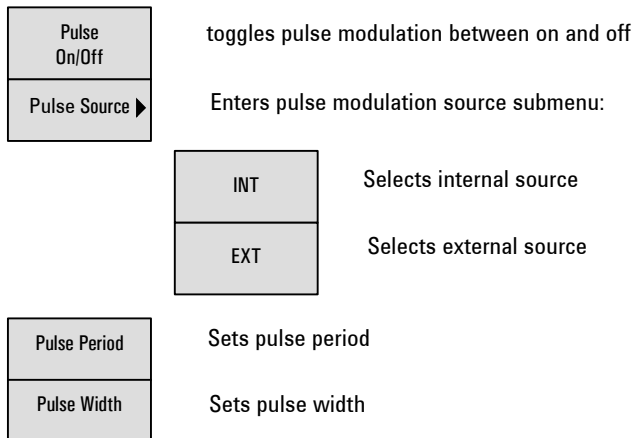
Pressing  hardkey reveals a submenu for pulse modulation configurations.



Pulse On Off Pressing this softkey enables the pulse modulation and then a PULSE annunciator displays when you enable a pulse modulation. However, the RF carrier is modulated only when you also enabled the RF output by pressing the  hardkey and the  annunciator displays.

- Default value: **Off**
- Key sequence:  > **Pulse On Off**

Pulse Source Pressing this softkey reveals a menu of choices for pulse modulation sources. Selecting INT connects the internally-generated, calibrated signal to the modulator, with a default setting of a 200 μ s pulse period and 100 μ s pulse width. Selecting EXT connects an external signal via the PULSE MOD IN connector on the rear panel.

- Default value: **INT**
- Key sequence:  > **Pulse Source**

Pulse Period Pressing this softkey modifies the pulse period of the internal pulse signal. The active function area displays the current pulse period value. The allowed value range is 200 μs to 2 s, with the minimum increment of 1 μs . The pulse period applies only to the internal pulse signal. If an external pulse source is selected, the **Pulse Period** softkey is disabled.

- Default value: 200 μs
- Key sequence:  > **Pulse Period**

Pulse Width Pressing this softkey modifies the pulse width for the internal pulse signal. The active entry area displays the current pulse width value. The allowed value range is 100 μs to 1 s, with the minimum increment of 1 μs . If an external pulse source is selected, the **Pulse Width** softkey is disabled.

- Default value: 100 μs
- Key sequence: **Pulse** > **Pulse Width**

Sweep

Pressing  reveals a menu of softkeys. Use these softkeys to define a series of points containing frequency, amplitude, and dwell time information for step sweep or list sweep.

Sweep State ▶	Enters sweep state submenu:
Off	Disables a sweep
RF	Enables radio frequency sweep mode
LF	Enables low frequency sweep mode
Ampl	Enables amplitude sweep mode
RF& Ampl	Enables RF&Ampl sweep mode
Step Scaling LOG/LIN	Toggles step scale between logarithm and linear
Sweep Type Step/List	Toggles sweep type between step and list
Sweep Repeat Single/Cont	Toggles sweep repeat between single and continuous
Step Sweep ▶	Enters step sweep configuration submenu:
RF Start	Sets RF sweep start frequency
RF Stop	Sets RF sweep stop frequency
LF Start	Sets LF sweep start frequency
LF Stop	Sets LF sweep stop frequency
# Point	Sets sweep points



Continued

	Ampl Start	Sets sweep stop amplitude
	Ampl Stop	Sets sweep start amplitude
	Step Dwell	Sets dwell time
List Sweep ▶	Enters list sweep configuration submenu	
	Edit Item	Edits the current item
	Insert Row	Inserts a new row below the current row
	Delete Row	Deletes the current row
	Goto Row	Jumps to a certain row
	Insert Item	Inserts a new item below the current item
	Delete Item	Deletes the current item
	Recall/Save	Recalls or saves list files (Please refer to the file menu)
	Dwell Type Step/List	Toggles dwell type between step and list
	Preset List	Presets the list
Sweep Trigger ▶	Enters sweep trigger submenu	
	Immediate	Initiates a sweep immediately
	Trigger Key	Triggers a sweep with trigger key



Continued

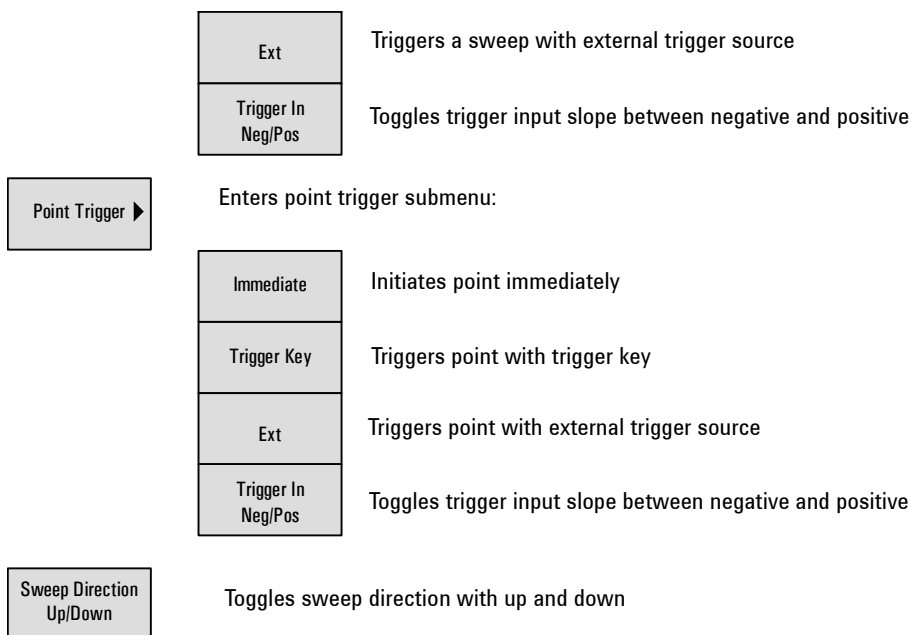

Sweep Mode Pressing this softkey reveals a menu for determining the sweep state and mode. Using its submenu selects an RF sweep, or an LF sweep, or an amplitude sweep, or an RF&Ampl sweep. Pressing **Sweep Mode > Off** turns off an on-going sweep, and the output signal is then set according to the current **Frequency** and **Amplitude** hardkey settings.

- Default value: **Off**
- Key sequence: **Sweep > Sweep Mode**

RF Pressing **Sweep Mode > RF** softkeys enables an RF sweep output via the RF OUT port. The amplitude is at a constant level defined by the **Amplitude** hardkey.

Key sequence: **Sweep > Sweep Mode > RF**

According to different sweep trigger and point trigger configuration cases, the signal generator produces an RF sweep differently:

Case 1. **Sweep trigger** and **Point trigger** are both set to **Immediate**: the signal generator initiates an RF sweep over the points immediately and automatically.

Case 2. **Sweep trigger** and **Point trigger** are both set to **Key**, pressing **Sweep** > **Sweep Mode** > **RF** arms an RF sweep and the signal generator requires you to press the **Trigger** hardkey to initiate a sweep and also press the **Trigger** hardkey to sweep over each of the points.

Case 3. **Sweep trigger** is set to **Key** while **Point trigger** is set to **Immediate**, pressing **Sweep** > **Sweep Mode** > **RF** arms an RF sweep. The signal generator requires you to press the **Trigger** hardkey to initiate the sweep and the signal generator will sweep over the points automatically.

Case 4. **Sweep trigger** is set to **Immediate** while **Point trigger** is set to **Key**, pressing **Sweep** > **Sweep Mode** > **RF** initiates an RF sweep immediately, but the signal generator requires you to press the **Trigger** hardkey to sweep over each of the points.

If you want to use an external trigger source, a TTL signal with 100 ns as the minimum level holding time is required. Only when the sweep trigger is set to **Key** and the point trigger is set to **EXT**, is the sweep repeat able to set to either **Single** or **Cont**. The other combinations of the sweep trigger and point triggers allows continuous sweep only.

LF Pressing this softkey enables an LF sweep output via the LF OUT connector. The amplitude is at a constant level defined by the **LF Out Ampl** softkey. This function is available only when the sweep type is set step sweep.

- Key sequence: **Sweep** > **Sweep Mode** > **LF**

Ampl Pressing this softkey enables an amplitude sweep output via the RF OUT connector. The frequency is set at a constant value determined by the **Frequency** hardkey.

- Key sequence: **Sweep** > **Sweep Mode** > **Ampl**

RF&Ampl Pressing this softkey enables an RF&Ampl sweep output via the RF OUT connector. Both the frequency and the amplitude can be set at arbitrary values. This function is available only when the sweep type is set list sweep.

- Key sequence:  > **Sweep Mode > RF&Ampl**

NOTE

Performing similarly with the RF sweep, the signal generator initiates an LF sweep or an amplitude sweep differently, according to the combination settings of the sweep trigger and point trigger. Please refer to the RF sweep on previous page for detailed information.

Step Scale LOG/LIN Pressing this softkey toggles the step scale between linear or logarithmic for RF sweep only. The LF sweep and amplitude sweep allow linear scale only.

- Default value: **LIN**
- Key sequence: **Sweep > Step Scale**





Sweep Repeat Cont/Single Pressing this softkey toggles the sweep repetition between single and continuous. **Continuous** means the signal generator automatically sweeps and cycles the sweep. **Single** means the signal generator sweeps one cycle. Pressing **Enter** hardkey enables a second cycle of single sweep again, in condition that the sweep trigger and the point trigger are both set to **Immediate**.





- Default value: **Cont**
- Key sequence:  > **Sweep Repeat**







Step Sweep Pressing this softkey reveals a submenu of softkeys to configure the parameters of a step sweep, including:

- RF/LF start and stop frequencies
- Amplitude start and stop power levels
- Number of points in a sweep and the dwell time at each point.

- Key sequence:  > **Step Sweep**

- RF Start** Pressing this softkey allows you to set the start frequency in an RF sweep. The allowed range is 9 kHz to 3 GHz, with 0.1 Hz minimum increment. The start frequency should always be set less than the stop frequency in an RF sweep.
- Default value: **9.0000 kHz**
 - Key sequence:  > **Step Sweep > RF Start**
- RF Stop** Pressing this softkey allows you to set the stop frequency in an RF sweep. The allowed range is 9 kHz to 3 GHz, with 0.1 Hz minimum increment. The stop frequency should always be set greater than the start frequency.
- Default value: **3.000 000 0000 GHz**
 - Key sequence:  > **Step Sweep > RF Stop**
- LF Start** Pressing this softkey allows you to set the start frequency in an LF sweep. The allowed range is 20 Hz to 80 kHz, with 0.1 Hz minimum increment. The start frequency should always be set less than the stop frequency in an LF sweep.
- Default value: **20.0 Hz**
 - Key sequence:  > **Step Sweep > LF Start**
- LF Stop** Pressing this softkey allows you to set the stop frequency in an LF sweep. The allowed range is 20 Hz to 80 kHz, with 0.1 Hz minimum increment. The stop frequency should always be set greater than the start frequency.
- Default value: **80.0000 kHz**
 - Key sequence:  > **Step Sweep > LF Stop**
- # Points** Pressing this softkey sets the number of points in a sweep. The allowed range is 2 to 1001 points.
- Default value: **10**
 - Key sequence:  > **Step Sweep > # points**

- Ampl Start** Pressing this softkey sets the start amplitude in an amplitude sweep. The allowed range is -127 dBm to 13 dBm, with 0.1 dB minimum increment. The start amplitude should always be set less than the stop one in an amplitude sweep.
- Default value: **-127.0 dBm**
 - Key sequence:  > **Step Sweep > Ampl Start**
- Ampl Stop** Pressing this softkey sets the stop amplitude in an amplitude sweep. The allowed range is -127 dBm to 13 dBm, with 0.1 dB minimum increment. The stop amplitude should always be set greater than the start amplitude.
- Default value: **-126.0 dBm**
 - Key sequence:  > **Step Sweep > Ampl Stop**
- Step Dwell** Pressing this softkey sets the dwell time for each point of a step sweep. The dwell time is the amount of time the sweep maintains a frequency or power for the current sweep point. The allowed valued range is 10 ms to 1 s, with 0.1 ms minimum increment.
- Default value: **10.0 ms**
 - Key sequence:  > **Step Sweep > Step Dwell**
- List Sweep** Pressing this softkey reveals a submenu to configure the parameters of a list sweep, including:
- frequency at each point
 - Amplitude power level at each point
 - Number of sweep points, the dwell time at each point.
 - Key sequence:  > **List Sweep**
- Edit Item** Pressing this softkey allows you to edit the current highlighted item . The knob helps you select the item to edit. You can use numeric keys on the front panel to input the corresponding value and terminate it with a unit softkey.
- Key sequence:  > **List Sweep > Edit Item**

- Insert Row** Pressing this softkey allows you to insert a new row below the current row.
- Key sequence:  > **List Sweep** > **Insert Row**
- Delete Row** Pressing this softkey allows you to delete the current row. Notice that the current table should have at least two rows. So if there are only two rows in the current table, you can't delete a row any more.
- Key sequence:  > **List Sweep** > **Delete Row**
- Goto Row** Pressing this softkey reveals a submenu which allows you to jump to a certain row. You can use numeric keys on the front panel to input the row number and end it with the softkey **Enter**. If the row you want to jump to is not in the current table, you can use the softkeys **Page Up** or **Page Down** to locate the destined table.
- Key sequence:  > **List Sweep** > **Goto Row**
- Insert Item** Pressing this softkey allows you to insert a new item below the current item.
- Key sequence:  > **List Sweep** > **Insert Item**
- Delete Item** Pressing this softkey allows you to delete the current highlighted item.
- Key sequence:  > **List Sweep** > **Delete Item**
- Recall/Save** Pressing this softkey allows you to recall or save list files. Operations are similar to the file function.
- Key sequence:  > **List Sweep** > **Recall/Save**
- Dwell Type Step/List** Pressing this softkey toggles the dwell type between step and list. **Step** means the dwell time for each point in the list table is equal to the dwell time set in step sweep. **List** means the dwell time for each point in list sweep will be set independently in the list table.
- Key sequence:  > **List Sweep** > **Dwell Type**

Preset List Pressing this softkey presets two rows of data in the list table. It allows you to edit your own testing sequence based on these two rows.

- Key sequence:  > **List Sweep > Preset List**

Sweep Trigger Pressing this softkey reveals a submenu of choices for triggering a full sweep. Use this softkey to select triggering immediately, triggering by the  hardkey, or triggering on either the positive or negative edge of a signal supplied to the TRIGGER IN connector.

- Default value: **Immediate**
- Key sequence:  > **Sweep Trigger**

Point Trigger Pressing this softkey reveals a submenu of choices for triggering a sweep point-by-point. Use this softkey to select the way triggering the next sweep point after the dwell time of the previous point as triggering immediately and automatically, or triggering by pressing the  hardkey, or triggering on either the positive or negative edge of an external signal supplied to the TRIGGER IN connector.

- Default value: **Immediate**
- Key sequence:  > **Point Trigger**

Immediate This softkey is one of the choices in both the **Sweep Trigger** and the **Point Trigger** submenu. If you set both the **Sweep Trigger** and the **Point Trigger** to **Immediate**, the signal generator initiates a sweep over all the points as soon as you select a sweep mode (**RF/LF/Ampl**).



- Key sequence:  > **Sweep Trigger > Immediate**
 > **Point Trigger > Immediate**

Trigger key This softkey is one of the choices in both the **Sweep Trigger** and the **Point Trigger** submenu. If you set both the **Sweep Trigger** and the **Point Trigger** to **key**, the signal generator arms a sweep as you select a sweep mode and requires you to press the  hardkey to initiate a sweep point by point.

- Key sequence:  > **Sweep Trigger** > **Trigger Key**
 > **Point Trigger** > **Trigger Key**

EXT This softkey is one of the choices in both the **Sweep Trigger** and the **Point Trigger** submenu. Selecting **EXT** allows the external trigger source come in and triggers a sweep or each point in a sweep. The external trigger source should be a TTL signal with 100 ns minimum level holding time.

The signal generator also allows you to set the slope of the external trigger source by pressing **Trigger In** softkey: on either the negative or the positive edge of the TTL signal.

- Key sequence:  > **Sweep Trigger** > **EXT**
 > **Point Trigger** > **EXT**

Trigger In Pos/Neg Pressing this softkey toggles the slope of the TTL between positive and negative. This softkey is available only when the **EXT** is selected.

- Default value: **Neg**
- Softkey sequence:  > **Trigger In**

Sweep Direction Up /Down Changes the direction of sweep. Choose **Up** to sweep from start frequency/amplitude to the stop frequency/amplitude. Choose **Down** to reverse the direction of sweep.

- Default value: **Up**
- Key sequence:  > **Sweep Direction**

Trigger

Pressing  hardkey triggers an armed sweep or each point in a sweep. It is active only when you set either the sweep trigger or the point trigger to **Key**.

Utility

Pressing **Utility** hardkey reveals a submenu for configuring the system.

Display Style ▶	Enters the display style submenu:
Classic White	Sets display style to classic white
Modern Blue	Sets display style to Modern Blue
Jade Green	Sets display style to Jade Green
Screen Saver ▶	Enters the screen saver submenu:
On	Enables screen saver
Off	Disables screen saver
Error Info ▶	Enters error information submenu:
Page Up	Pages up the error information list
Page Down	Pages down the error information list
Clear	Clears the error information queue
Date/Time	Enters the date/time submenu:
Date	Sets date information
Time	Sets time information

▼ next page





Ref Setups ▶	Enters the reference source submenu:
INT-10 MHz	Selects 10 MHz internal reference source
EXT-2 MHz	Selects 2 MHz external reference source
EXT-5 MHz	Selects 5 MHz external reference source
EXT-10 MHz	Selects 10 MHz external reference source
Information	Displays system information
Opt. Φ Noise	Enters the phase noise optimize mode menu
Normal	Selects normal phase noise mode
ResFM Opt.	Optimizes Residual FM
License Key	Inputs License Key to enable an option

Display Style Pressing this softkey allows you to choose a display style (**Classic White/Modern Blue/Jade Green**).

- Default value: **Modern Blue**
- Key sequence: **Utility** > **Display style**

Screen saver Pressing this softkey toggles the signal generator’s screen saver between on and off. With the screen saver on, the screen is turned off after standing by for 15 minutes. The screen is turned on by pressing any front panel key (except for the standby switch), or when the generator receives a remote command.

- Default value: **Off**
- Key sequence: **Utility** > **Screen Saver**

- Error Info** Pressing this softkey reveals a menu of choices for viewing error messages. Pressing **Page up/down** allows you to view previous/next page. Pressing **Clear** deletes all the messages stored in the error message queue. You cannot recover from this action; once the messages are deleted, they are permanently gone. When the error message queue is empty, the ERR annunciator is turned off.
- Key sequence:  > **Error Info**
- Date/Time** Pressing this softkey allows you to set the system date/time. Set system date with the **Set date** softkey. The data display format is YYYY-MM-DD. Set system time with the **Set time** softkey. The time display format is HH:MM.
- Key sequence:  > **Date/time**
- Ref Setup** Pressing this softkey sets the reference oscillator of the signal generator to any of the choices: internal 10 MHz, external 2, 5 or 10 MHz reference oscillator.
- Default value: **INT-10 MHz**
 - Key sequence:  > **Ref Setups**
- Information** Pressing this softkey displays the system information of the signal generator. The displayed information includes:
- instrument model
 - instrument serial number
 - current firmware version
 - option status
 - hardware information
 - Key sequence:  > **Information**

Opt. Φ Noise Pressing this softkey allows you to set the phase noise mode: **ResFM Opt.** or **Normal**. Selecting **ResFM Opt.** improves the residual FM performance, comparing with **Normal** mode.

- Default value: **Normal**
- Key sequence:  > **Opt. Φ Noise**

License Key Pressing this softkey when you need to enter a license key for option identifications. Refer to “[Enable an option](#)” on page 25 for an example of using this function.

- Key sequence:  > **License Key**



5 Programming Fundamentals

Remotely Operating Your N9310A 88

Getting Started with SCPI 93

IEEE 488.2 common command 101

Remotely Operating Your N9310A

The signal generator provides USB (Universal Serial Bus) connection and allows you to set up a remote operation environment via the USB interface with a controller computer. A controller computer can be a personal computer (PC), a minicomputer. Some intelligent instruments can also function as controllers.

Preparing equipments for Remote Operation

Usually, you need to prepare an IBM compatible PC with the following requirements to set up a remote operation environment:

Processor:

- 450 MHz or higher required

Operating system:

- Microsoft® Windows® XP, or Windows® 2000 Professional, service pack 4 or later

Video: SGVA (800 * 600 or greater) 256 colors

Available memory:

- 64 MB required

Available disk space: 175 MB or greater required

Connecting the N9310A to a PC via the USB Port

No extra driver is required to connect the N9310A via the USB port to a PC. All you need is the Agilent IO Libraries Suite version 14.1 or later, and you can find this IO libraries suite in the documentation CD in the shipment along with your N9310A. Or download the IO Libraries Suit from Agilent website:

<http://www.agilent.com/find/iolib>

Refer to the following steps to finish the connection:

- 1 Install IO Libraries Suite
- 2 Switch on the N9310A
- 3 Connecting the signal generator to a PC with a USB cable

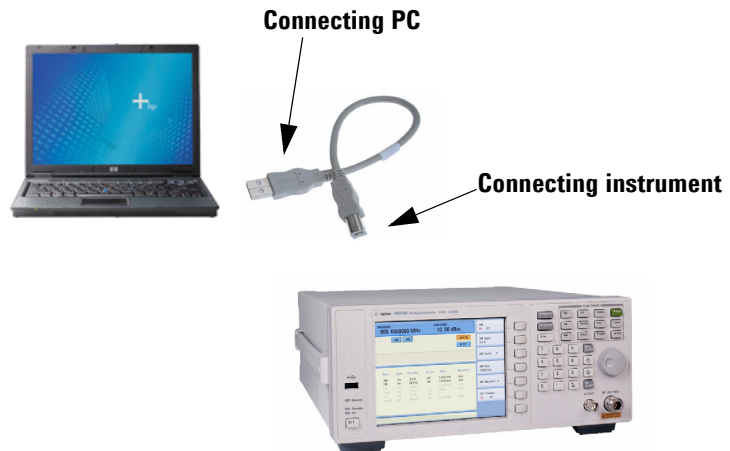

- 4 After a while, the PC finds your N9310A as a new hardware and prompts a message saying "Found new hardware...". A **Found New Hardware Wizard** is initiated immediately.



5 Select **Display a list...**

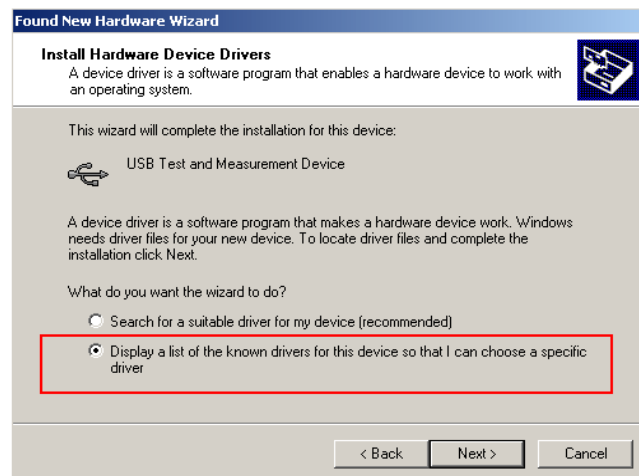

- 6 Windows should find **USB Test and Measurement Device**. Select it and press **Next**.

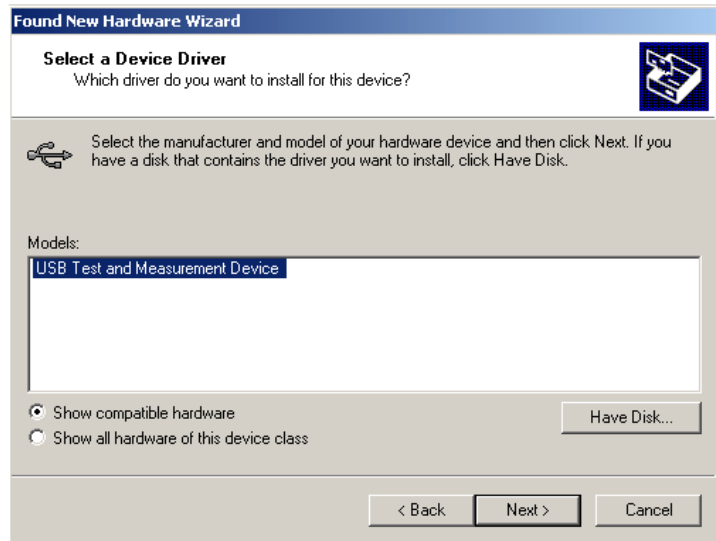

- 7 The wizard will guide you through the rest of installation till the driver is installed.
- 8 Open Agilent Connection Expert in your IO Libraries Suite, your N9310A will be detected automatically. If not, press **Refresh All**.

About USB Interface

A USB connection is typically easy to setup and very cost effective. The USB specification supports a wide selection of devices that range from lower-speed devices, such as keyboards and mice to higher-speed devices, such as digital camera and intelligent instrument.

The USB interface initially offers up to 12 Mb/S. That is about 100 times faster than the RS-232 style serial interfaces used in earlier generations. A USB 2.0 connection is also faster than a LAN or GPIB connection.

USB Connector Types

Many USB devices come with their own built-in cable, with an “A” connection on it. If not, then the device has a socket on it that accepts a USB “B” connector. The USB standard uses “A” and “B” connectors to avoid confusion.

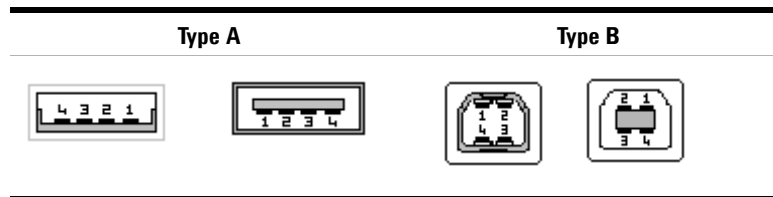

Pin Map of USB Connectors

Pin #	Pin caption	Description
1	VCC	+5 V, DC
2	D -	Data -
3	D +	Data +
4	GND	Ground

Please refer to <http://www.usb.org> for details.

Getting Started with SCPI

Programming with SCPI (Standard Command of Programmable Instrument) requires following knowledges:

- Computer programming languages, such as C, C++, and Microsoft®Visual Basic®.
- The language of your instrument. The N9310A employs SCPI as its programming language.

The semantic requirements of your controller's language determine how the programming commands and responses are handled in your application program.

An Introduction to the SCPI Language

SCPI is an ASCII-based instrument command language designed for test and measurement instruments, with the goal of reducing automatic test equipment (ATE) program development time.

SCPI accomplishes this goal by providing a consistent programming environment for instrument control and data usage. This consistent programming environment is achieved by the use of defined program messages, instrument responses, and data formats across all SCPI instruments.

By providing a consistent programming environment, replacing one SCPI instrument with another SCPI instrument in a system will usually require less effort than with non-SCPI instrument.

SCPI is not a standard which completely provides for interchangeable instrumentation. SCPI helps move toward interchangeability by defining instrument commands and responses, but it does not define instrument functionality, accuracy, resolution, connectors, etc.

Common Terms used in this Book

Terms	Description
Controller	Any computer used to communicate with an instrument. A controller can be a personal computer (PC), a minicomputer, or a plug-in card in a card cage. Some intelligent instruments can also function as controllers.
Instrument	Any device that implements SCPI. Most instruments are electronic measurement or stimulus devices, but this is not a requirement. Similarly, most instruments use a GPIB or RS-232 or USB interface for communication. The same concepts apply regardless of the instrument function or the type of interface used.
Command	An instruction. You combine commands to form messages that control instruments to complete a specified task. In general, a command consists of mnemonics (keywords), parameters and punctuation.
Query	A special type of command. Queries instruct the instrument to make response data available to the controller. Query keywords always end with a question mark, ? .

Reference material:

IEEE Standard 488.1-1987, *IEEE Standard Digital Interface for Programmable Instrumentation*, New York, NY, 1998.

IEEE Standard 488.2-1987, *IEEE Standard Codes, Formats, Protocols and Comment Commands for Use with ANSI/IEEE Std 488.1-1987*, New York, NY, 1998.

Command Categories

The SCPI command falls into two categories:

- Subsystem commands that simulate front panel keystrokes
- Common commands that are unique and have no front panel equivalent

Use a computer to control the signal generator (but operate the line power switch manually). Computer programming procedures for the signal generator involve selecting a programming statement and then adding the specified programming codes to that statement to achieve the desired operating conditions.

Command Syntax

Command syntax includes standard notations and statement rules.

Standard Notations

A command consists of mnemonics (keywords), parameters and punctuation. Before you start to program your signal generator, familiarize yourself with the standard notation of each of them. See the table on next page.

Command Mnemonics (keywords)	<p>Many commands have both a long and a short form: use either one. (a combination of the two is not allowed). Consider the :FREQuency command for example:</p> <ul style="list-style-type: none">• Short form :FREQ• Long form :FREQUENCY <p>SCPI is not case sensitive, so fREquEncy is just as valid as FREQUENCY, but FREQ and FREQUENCY are the only valid forms of the FREQuency command.</p> <p>In this documentation, upper case letters indicate the short form of the keyword. The lower case letters indicate the long form of the keyword.</p>
Punctuation	<ul style="list-style-type: none">• A vertical bar " " dictates a choice of one element from a list. For example: <A> indicates that either A or B can be selected, but not both.• Square brackets "[]" indicates that the enclosed items are optional.• Angle brackets "< >" indicates a variable items to be entered to represent user choices.• A question mark "?" after a subsystem command indicates that the command is a query. The returned information, <value> varies in format according to the type of the field.
Separator	<ul style="list-style-type: none">• A colon ":" seperates keywords of different levels.• A space separates a keyword and a parameter, as well as a parameter and a unit.

The colon before the root keyword is usually omitted.

Command Statement Rules Overview

Besides the standard notation of SCPI described in previous page, SCPI uses the following rules:

- Command statements read from left to right
- Use either long form or short form of keywords, but do not use both
- no separating space between the keywords, only use a colon to separate keywords of different levels
- always separating a keyword from a variable with a space
- always separating a variable from its unit with a space (if variable has a unit)

Take “:AM:DEPTh <val>” for example,

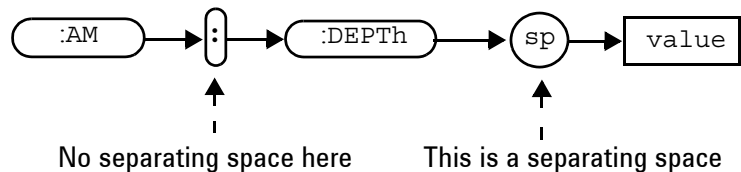

Using Valid Commands

The following examples demonstrate valid and invalid commands.

Example 1 **:FREQ: CW 900 MHz**

In this example, the keyword short form is used. The command is correct and will not cause errors.

It is equivalent to front panel key access **Frequency > 900 > MHz**

Example 2 `:AMPLITUDE:CW -85 dBm`

In this example, the keyword long form is used. The command is correct and will not cause errors.

It is equivalent to front panel key access **Amplitude > - 85 > dBm**

NOTE

Always enter the minus symbol with English language environment settled in your PC. Minus symbol of any other language is recognized as invalid symbol.

Example 3 `freq:cw 900 mhz`

In this example, the keyword lowercase is used and the leading colon is omitted. The command is correct and will not cause errors. It will have the same effect as the command message that is in uppercase.

Example 4 `fre:cw 900mhz`

The command is incorrect and will cause errors. It uses incorrect keyword “fre”, which is not the standard short form and can not be recognized by program. Another error of this program message is that there is no space between 900 and Mhz.

Program and Response Messages

To understand how your instrument and controller communicate using SCPI, you must understand the concepts of program and response messages.

Program Messages

Program messages are the formatted data sent from the controller to the instrument. Conversely, response messages are formatted data sent from the instrument to the controller. Program messages contain one or more commands, and response messages contain one or more responses.

Response Messages

The controller may send commands at any time, but the instrument sends responses only when query commands is received. All query mnemonics end with a question mark. Queries return either measured values or internal instrument settings.

Forgiving Listening and Precise Talking

SCPI uses the concept of forgiving listening and precise talking outlined in IEEE 488.2.

Forgiving listening means that instruments are very flexible in accepting various command and parameter formats. For example, the signal generator accepts either

:RFOutput:STATE ON or **:RFOutput:STATE 1**

Precise talking means that the response format for a particular query is always the same. For example, if you query RF output state when it is on (using **:RFOutput:STATE?**), the response is always 1, regardless of if you previously sent **:RFOutput:STATE 1** or **:RFOutput:STATE ON**.

1 represents logic state 1 = ON; logic state 0 = OFF

Subsystem Command Trees

Most programming tasks involve subsystem commands that are usually specified to simulate front panel keystrokes. SCPI uses a hierarchical structure for subsystem commands similar to the file system on most computers. In SCPI, this command structure is called a command tree. It helps you to understand how the subsystem commands simulate front panel operations.

How to Use a Command Tree

In the command tree example shown below, the command closest to the left is the root command, or simply “the root”. Notice that you must follow a particular path to reach lower level sub-commands.

In this example, `:LFOutput` is the root keyword of the tree, `FREQuency`, `AMPLitude` and `STATe` are second-level keywords. If you wish to access the `STATe?` command, you must follow the path `:LFOutput:STATe?`

Example 5 Low Frequency Output Subsystem

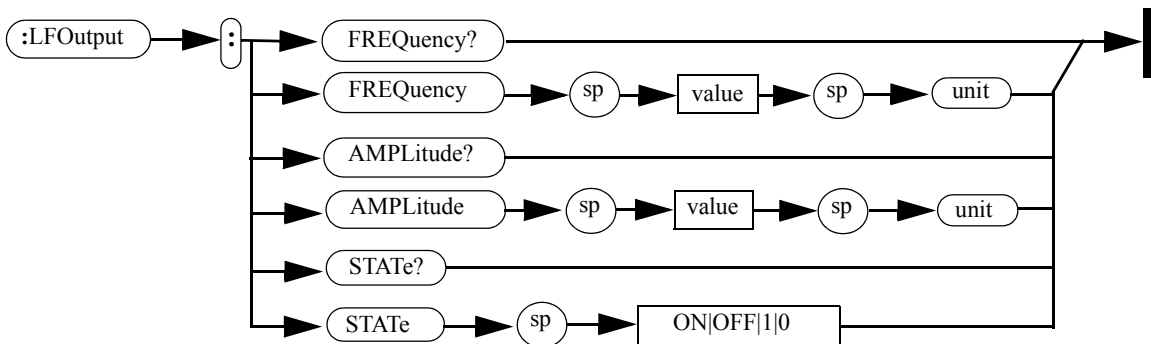

IEEE 488.2 common command

Common commands are generally not measurement related, but are used to manage macros, status registers, synchronization, and data storage. The common commands are defined by IEEE 488.2.

All common commands begin with an asterisk. The following common commands are available in N9310A.

***RST (Reset)**

Using this command resets the signal generator to factory default settings and returns the instrument to a state where it waits for a command to initiate other actions. See [“Preset”](#) on page 70 for an overview of the factory default settings of the signal generator.

***IDN? (Identification)**

This is a query only command. After sending this query, the signal generator reports the following identification information:

- Manufactory title
- Instrument module
- Instrument serial number
- Firmware version number

***CLS (Clear Status)**

Using this command clears the error queue of the signal generator. There is no equivalent front panel key access.



6 Subsystem Command Reference

Preparing for Use	104
Frequency Subsystem	107
Amplitude Subsystem	111
Trigger Subsystem	113
Sweep Subsystem	114
AM Subsystem	130
FM Subsystem	133
Phase Modulation Subsystem	136
Pulse Modulation Subsystem	138
I/Q Modulation Subsystem	140
Utility Subsystem	141
Modulation State Subsystem	145
RF Output State Subsystem	146
LF Output Subsystem	147
Subsystem Command Trees	149
Programming Examples	159

Preparing for Use

Subsystem commands include all measurement functions and some general-purpose functions.

Subsystem Commands Overview

Each of the following subsystems is a set of commands that broadly corresponds to a functional block of the instrument.

- [“Frequency Subsystem”](#) on page 107
Provides SCPI commands to configure frequency related items.
- [“Amplitude Subsystem”](#) on page 111
Provides SCPI commands to configure amplitude related items.
- [“Trigger Subsystem”](#) on page 113
Provides SCPI commands to configure a trigger event.
- [“Sweep Subsystem”](#) on page 114
Provides SCPI commands to configure an RF step sweep, or an LF step sweep, or an amplitude step sweep. It also provides configuration commands that configure the trigger mode associated with any step sweep mode.
- [“AM Subsystem”](#) on page 130
Provides SCPI commands to configure an AM signal.
- [“FM Subsystem”](#) on page 133
Provides SCPI commands to configure an FM signal.
- [“Phase Modulation Subsystem”](#) on page 136
Provides SCPI commands to configure a phase modulation signal.

- [“Pulse Modulation Subsystem”](#) on page 138
Provides SCPI commands to configure a pulse modulation signal.
- [“I/Q Modulation Subsystem”](#) on page 140
Provides SCPI command to configure the state of the I/Q modulation.
- [“Utility Subsystem”](#) on page 141
Provides SCPI commands to configure the instrument system settings.
- [“Modulation State Subsystem”](#) on page 145
Provides SCPI command to manage the modulator's state for AM, FM, Phase modulation, and Pulse modulation.
- [“RF Output State Subsystem”](#) on page 146
Provides a command to manage the RF output state for CW output, RF/Amplitude sweep output, and modulation output.
- [“LF Output Subsystem”](#) on page 147
Provides SCPI commands to configure the LF output.

Conventions used in Programming

- Use "us" instead of "μs" in your coding when describing microsecond.
- Always enter a minus symbol with English language environment settled in your PC.
- The returned data of a query keeps to the following rules:
 - a boolean variable returns 1|0. (1= On, 0= Off)
 - an enumerative variable returns its short form normally. For example, :SWEep:REPeat? returns SING, indicating the current sweep repeat is in single mode.
 - a minority of enumerative variable return their specified format. For example, :SYSTem:REFerence:FREQuency? returns EXT10MHZ, indicating the current reference is set to external 10 MHz oscillator.
- If the variable contains a parameter and a unit, with a space between them, the returned data also consists of a parameter and a unit with the best match telling the magnitude. For example, :FREQ: CW? returns a parameter with different magnitude unit:
 - "60.0000 kHz" ($9 \text{ kHz} \leq \text{Frequency} < 1 \text{ MHz}$)
 - "450.0000000 MHz" ($1 \text{ MHz} \leq \text{Frequency} < 1 \text{ GHz}$)
 - "1.562000000 GHz" ($\text{Frequency} \geq 1 \text{ GHz}$)

Frequency Subsystem

The frequency subsystem controls the settings and parameters associated with frequency.

Continuous Wave (CW) Output Frequency

```
:FREQUENCY:CW <val> <unit>
```

```
:FREQUENCY:CW?
```

This command sets the frequency of a CW signal.

The query returns the current frequency of a CW signal.

Range	9 kHz to 3 GHz
Valid unit	GHz, MHz, kHz
Minimum increment	0.1 Hz
*RST value	3.000 000 0000 GHz
Returned data format	<val> <unit>
Front panel access	

RF Start

```
:FREQUENCY:RF:START <val> <unit>
```

```
:FREQUENCY:RF:START?
```

This command sets the start frequency in an RF sweep. The start frequency should always be lower than stop frequency in an RF sweep.

The query returns the current start frequency.

Range	9 kHz to 3 GHz
Valid unit	GHz, MHz, kHz
Minimum increment	0.1 Hz
*RST value	9.0000 kHz
Returned data format	<val> <unit>
Front panel access	Sweep > Step Sweep > RF Start

RF Stop

```
:FREQUENCY:RF:STOP <val> <unit>
```

```
:FREQUENCY:RF:STOP?
```

This command sets the stop frequency in an RF sweep. The stop frequency should always be set higher than the start frequency.

The query returns the current stop frequency.

Range	9 kHz to 3 GHz
Valid unit	GHz, MHz, kHz
Minimum increment	0.1 Hz
*RST value	3.000 000 0000 GHz
Returned data format	<val> <unit>
Front panel access	Sweep > Step Sweep > RF Stop

LF Start

```
:FREQUENCY:LF:START <val> <unit>
```

```
:FREQUENCY:LF:START?
```

This command sets the start frequency in an LF sweep. The start frequency should always be lower than the stop frequency in an LF sweep.

The query returns the current start frequency.

Range	20 Hz to 80 kHz
Valid unit	kHz, Hz
Minimum increment	0.1 Hz
*RST value	20.0 Hz
Returned data format	<val> <unit>
Front panel access	Sweep > Step Sweep > LF Start

LF Stop

```
:FREQUENCY:LF:STOP <val> <unit>
```

```
:FREQUENCY:LF:STOP?
```

This command sets the stop frequency in an LF sweep. The stop frequency should always be set higher than the start frequency.

The query returns the current stop frequency.

Range	20 Hz to 80 kHz
Valid unit	kHz, Hz
Minimum increment	0.1 Hz
*RST value	80.0000 kHz
Returned data format	<val> <unit>
Front panel access	Sweep > Step Sweep > LF Stop

Step Scale

```
:FREQuency:RF:SCALe LOG|LIN
```

```
:FREQuency:RF:SCALe?
```

This command toggles the scale of an RF sweep between logarithmic and linear.

The LOG scale is NOT applicable to neither amplitude sweep nor LF sweep.

The query returns the current scale.

Range	LOG, LIN
*RST value	LIN
Returned data	LOG, LIN
Front panel access	Sweep > Step Scale

Amplitude Subsystem

The amplitude subsystem controls the settings and parameters associated with amplitude.

Continuous Wave Output Amplitude

```
:AMPLitude:CW <val> <unit>
```

```
:AMPLitude:CW?
```

This command sets the amplitude of CW output.

The query returns the current amplitude of CW output.

Range and unit	-127 to +13 dBm, (+20 dBm settable) -80 to +60 dBmV, (+67 dBmV settable) -20 to +120 dBμV, (+127 dBμV settable) 0.0001 to 1000 mV, (2238.8 mV settable) 0.1 to 1 000 000 μV, (2238800 μV settable)
Minimum increment	0.1 dB (When using dBm/dBmV/dBμV) 0.1 mV (When using mV) 0.1 μV (Ampl ≤ 999.9 μV) 100 μV (Ampl ≥ 1000 μV)
*RST value	-127.0 dBm
Returned data format	<val> <unit>
Front panel access	

Amplitude Start

```
:AMPLitude:START <val> <unit>
```

```
:AMPLitude:START?
```

This command sets the start amplitude in an amplitude sweep. The start amplitude should always be lower than the stop amplitude in an amplitude sweep.

The query returns the current start amplitude.

Range	-127 to +13 dBm
Valid unit	dBm
Minimum increment	0.1 dBm
*RST value	-127.0 dBm
Returned data format	<val> <unit>
Front panel access	Sweep > Step Sweep > Ampl Start

Amplitude Stop

```
:AMPLitude:STOP <val> <unit>
```

```
:AMPLitude:STOP?
```

This command sets the stop amplitude in an amplitude sweep. The stop amplitude should always be higher than the start amplitude.

The query returns the current stop amplitude.

Range	-127 to +13 dBm
Valid unit	dBm
Minimum increment	0.1 dB
*RST value	13.0 dBm
Returned data format	<val> <unit>
Front panel access	Sweep > Step Sweep > Ampl Stop

Trigger Subsystem

The trigger subsystem controls the settings and parameters associated with triggering a sweep.

Immediate Trigger

:TRIGger:IMMediate

This command has no effect unless sweep is armed. It has an equivalent function to the  hardkey in activating an armed sweep.

There is no query for this command.

Front panel access: 

Single Sweep

:TRIGger:SSWP

This command initiates a single RF/LF/Amplitude sweep when the following conditions are met:

- Sweep trigger and point trigger are both set to IMMediate
- Sweep repeat is set to SINGLE
- An RF/LF/Amplitude sweep is enabled and first free run of the sweep is complete

There is no query for this command.

Front panel access: 

Sweep Subsystem

The sweep subsystem controls the settings and parameters associated with an RF/LF/Amplitude/RF&Ampl sweep.

NOTE

To make an RF/amplitude sweep available at the RF OUT connector, make sure you enable RF output. See “[RF Output State Subsystem](#)” on page 146

RF Sweep State

```
:SWEep:RF:STATe ON|OFF|1|0
```

```
:SWEep:RF:STATe?
```

This command initiates the signal generator to sweep in a different manner, according to the sweep trigger or point trigger settings:

- If the sweep trigger and point trigger are both set to IMMEDIATE, sending this command below initiates an RF sweep immediately:
":SWEep:RF:STATe ON"
- If either the sweep trigger or point trigger is set to KEY, sending the commands ":SWEep:RF:STATe ON" arms an RF sweep.
Sending command ":TRIGger IMMEDIATE" initiates the RF sweep.
- If either the sweep trigger or point trigger is set to EXT, sending the commands ":SWEep:RF:STATe ON" arms an RF sweep. No further command is needed to initiate the RF sweep, but a proper external signal should be input into the signal generator.

The query returns a current RF sweep state.

Range	On (1), OFF (0)
*RST value	OFF
Returned data	1, 0
Front panel access	Sweep > Sweep Mode > RF/Off

LF Sweep State

`:SWEep:LF:STATe ON|OFF|1|0`

`:SWEep:LF:STATe?`

This command initiates your signal generator to sweep in a different manner, according to the sweep trigger or point trigger settings:

- If the sweep trigger and point trigger are both set to IMMEDIATE, sending the following command initiates an LF sweep immediately:
`":SWEep:LF:STATe ON"`
- If either the sweep trigger or point trigger is set to KEY, sending the command `":SWEep:LF:STATe ON"` arms an LF sweep:
 Sending command `":TRIGger IMMEDIATE"` initiates the LF sweep.
- If either the sweep trigger or point trigger is set to EXT, sending the commands `":SWEep:LF:STATe ON"` arms an LF sweep. No further command is needed to initiate the LF sweep, but a proper external signal should be input into the signal generator.

The query returns the current LF sweep state.

Range	On (1), OFF (0)
*RST value	OFF
Returned data	1, 0
Front panel access	Sweep > Sweep Mode > LF Sweep > Sweep Mode > Off (abort an on-going LF sweep)

Amplitude Sweep State

```
:SWEep:AMPLitude:STATe ON|OFF|1|0
```

```
:SWEep:AMPLitude:STATe?
```

This command initiates your signal generator to sweep in a different manner, according to the sweep trigger or point trigger settings:

- If the sweep trigger and point trigger are set to IMMEDIATE, sending the command `:SWEep:AMPLitude:STATe ON` initiates an amplitude sweep immediately:
- If either the sweep trigger or point trigger is set to KEY, sending the command `:SWEep:AMPLitude:STATe ON` arms an amplitude sweep. Sending command `:TRIGger IMMEDIATE` initiates the amplitude sweep.
- If either the sweep trigger or point trigger is set to EXT, sending the commands `:SWEep:AMPLitude:STATe ON` arms an amplitude sweep. No further command is needed to initiate the amplitude sweep, but a proper external signal should be input into the signal generator.

The query returns the current amplitude sweep state.

Range	On (1), OFF (0)
*RST value	OFF
Returned data	1, 0
Front panel access	Sweep > Sweep Mode > Amplitude Sweep > Sweep Mode > Off

RF Start

```
:SWEep:RF:START <val> <unit>
```

```
:SWEep:RF:START?
```

This command sets the start frequency in an RF sweep. The start frequency should always be lower than the stop frequency in an RF sweep.

The query returns the current start frequency.

Range	9 kHz to 3 GHz
Valid unit	GHz, MHz, kHz
Minimum increment	0.1 Hz
*RST value	9.0000 kHz
Returned data format	<val> <unit>
Front panel access	Sweep > Step Sweep > RF Start

RF Stop

```
:SWEep:RF:STOP <val> <unit>
```

```
:SWEep:RF:STOP?
```

This command sets the stop frequency in an RF sweep. The stop frequency should always be set higher than the start frequency.

The query returns the current stop frequency.

Range	9 kHz to 3 GHz
Valid unit	GHz, MHz, kHz
Minimum increment	0.1 Hz
*RST value	3.000 000 0000 GHz
Returned data format	<val> <unit>
Front panel access	Sweep > Step Sweep > RF Stop

LF Start

```
:SWEep:LF:START <val> <unit>
```

```
:SWEep:LF:START?
```

This command sets the start frequency in an LF sweep. The start frequency should always be lower than the stop frequency in an LF sweep.

The query returns the current start frequency.

Range	20 Hz to 80 kHz
Valid unit	kHz, Hz
Minimum increment	0.1 Hz
*RST value	20.0 Hz
Returned data format	<val> <unit>
Front panel access	Sweep > Step Sweep > LF Start

LF Stop

```
:SWEep:LF:STOP <val> <unit>
```

```
:SWEep:LF:STOP?
```

This command sets the stop frequency in an LF sweep. The stop frequency should always be set higher than the start frequency.

The query returns the current stop frequency.

Range	20 Hz to 80 kHz
Valid unit	kHz, Hz
Minimum increment	0.1 Hz
*RST value	80.0000 kHz
Returned data format	<val> <unit>
Front panel access	Sweep > Step Sweep > LF Stop

Amplitude Start

```
:SWEep:AMPLitude:START <val> <unit>
```

```
:SWEep:AMPLitude:START?
```

This command sets the start amplitude in an amplitude sweep. The start amplitude should always be lower than the stop amplitude in an amplitude sweep.

The query returns the current start amplitude.

Range and unit	-127 to +13 dBm
Valid unit	dBm
Minimum increment	0.1 dB
*RST value	-127.0 dBm
Returned data format	<val> <unit>
Front panel access	Sweep > Step Sweep > Ampl Start

Amplitude Stop

```
:SWEep:AMPLitude:STOP <val> <unit>
```

```
:SWEep:AMPLitude:STOP?
```

This command sets the stop amplitude in an amplitude sweep. The stop amplitude should always be higher than the start amplitude.

The query returns the current stop amplitude.

Range and unit	-127 to +13 dBm
Valid unit	dBm
Minimum increment	0.1 dB
*RST value	13.0 dBm
Returned data format	<val> <unit>
Front panel access	Sweep > Step Sweep > Ampl Stop

Step Points

```
:SWEep:STEP:POINTs <val>
```

```
:SWEep:STEP:POINTs?
```

This command defines the number of points in a step sweep. A step sweep must always have a minimum of two points and can be configured to have as many as 1001 points.

The query returns the current number of points.

Range	2 to 1001
*RST value	10
Returned data format	<val>
Front panel access	Sweep > Step Sweep > # Points

Step Dwell

```
:SWEep:STEP:DWELl <val> <unit>
```

```
:SWEep:STEP:DWELl?
```

This command sets the dwell time for each point in a sweep. The query returns the current dwell time.

Range	10 ms to 1s
Valid unit	s, ms
Minimum increment	0.1 ms
*RST value	10.0 ms
Returned data format	<val> <unit>
Front panel access	Sweep > Step Sweep > Step Dwell

Sweep Type

```
:SWEep:TYPE STEP|LIST
```

```
:SWEep:TYPE?
```

This command toggles the sweep type between step and list. The query returns the current sweep type..

Range	STEP/LIST
*RST value	STEP
Returned data	STEP, LIST
Front panel access	Sweep > Sweep Type

List Power State

```
:LIST:POWEr:STATe ON|OFF|1|0
```

```
:LIST:POWEr:STATe?
```

This command toggles the RF&Ampl list between on and off. The query returns the current list power state.

Range	ON(1), OFF(0)
*RST value	OFF
Returned data	1, 0
Front panel access	Sweep > Sweep Mode > RF&Ampl Sweep > Sweep Mode > Off

List Dwell

```
:LIST:DWELL <val> <unit>
```

```
:LIST:DWELL?
```

This command sets the dwell time for the current list sweep point.

The query returns the current list sweep point's dwell time.

Range	10 ms to 1s
Valid unit	s, ms
Minimum increment	0.1 ms
*RST value	10.0 ms
Returned data format	<val> <unit>
Front panel access	Sweep > List Sweep > Edit Item

List RF

```
:LIST:RF <val> <unit>
```

```
:LIST:RF?
```

This command sets the frequency value for the current list sweep point.

The query returns the current list sweep point's frequency value.

Range	9 kHz to 3 GHz
Valid unit	GHz, MHz, kHz
Minimum increment	0.1 Hz
*RST value	9.0000 kHz
Returned data format	<val> <unit>
Front panel access	Sweep > List Sweep > Edit Item

List Amplitude

```
:LIST:Amplitude <val> <unit>
```

```
:LIST:Amplitude?
```

This command sets the amplitude value for the current list sweep point.

The query returns the current list sweep point's amplitude value.

Range and unit	-127 to +13 dBm
Valid unit	dBm
Minimum increment	0.1 dB
*RST value	13.0 dBm
Returned data format	<val> <unit>
Front panel access	Sweep > List Sweep > Edit Item

List Dwell Points

```
:LIST:DWELL:POINTs?
```

The query returns the number of dwell points in the current list sweep file.

List RF Points

```
:LIST:RF:POINTs?
```

The query returns the number of frequency points in the current list sweep file.

List Amplitude Points

```
:LIST:AMPLitude:POINTs?
```

The query returns the number of amplitude points in the current list sweep file.

List Row Goto

```
:LIST:ROW:GOTO <val>
```

```
:LIST:ROW:GOTO?
```

This command sets the list to the specified row.

The query returns the current row number.

Range	2 to 1001
*RST value	10
Returned data format	<val>
Front panel access	Sweep > List Sweep > Goto Row

List Row Insert

```
:LIST:ROW:INSert <val>
```

This command inserts a new row below the specified row.

Range	2 to 1001
*RST value	10
Front panel access	Sweep > List Sweep > Goto Row Sweep > List Sweep > Insert Row

List Row Delete

```
:LIST:ROW:DELeTe <val>
```

This command deletes the specified row in the list table.

Range	2 to 1001
*RST value	10
Front panel access	Sweep > List Sweep > Goto Row Sweep > List Sweep > Delete Row

List Rows

```
:LIST:ROWS?
```

This query returns the number of the current row in the list table.

Range	2 to 1001
Returned data format	<val>

List Preset

```
:LIST:PRESet
```

This command replaces the current list sweep data with a factory-defined file consisting of two rows.

Front panel access	Sweep > List Sweep > Preset
---------------------------	--

List Dwell Type

```
:LIST:DWELL:TYPE STEP|LIST
```

```
:LIST:DWELL:TYPE?
```

This command toggles the dwell time type between step and list.

The query returns the current list dwell type.

Range	STEP/LIST
*RST value	STEP
Returned data	STEP, LIST
Front panel access	Sweep > List Sweep > Dwell Type

Sweep Repeat

```
:SWEep:REPeat SINGLE|CONTInuous
```

```
:SWEep:REPeat?
```

This command toggles the sweep repeat between single and continuous.

The query returns the current sweep repeat state.

Range	SINGLE/CONTInuous
*RST value	CONTInuous
Returned data	SING, CONT
Front panel access	Sweep > Sweep Repeat

Sweep Trigger

```
:SWEep:STRG IMMediate|KEY|EXT
:SWEep:STRG?
```

This command sets the sweep trigger mode to one of the following choices:

- IMMediate - Selecting this mode immediately triggers signal generator to sweep from the first point to the final point in a sweep sequence automatically.
- KEY - Selecting this mode arms a sweep. The armed sweep will be initiated by sending the “TRIGger:IMMediate” command.
- EXT - Selecting this mode enables an external trigger source to initiate an armed sweep.

The query returns the current sweep trigger mode.

Range	IMMediate, KEY, EXT
*RST value	IMMediate
Returned data	IMM, KEY, EXT
Front panel access	Sweep > Sweep Trigger

External Sweep Trigger Slope

```
:SWEep:STRG:SLOPe EXTN|EXTP
:SWEep:STRG:SLOPe?
```

This command toggles the slope of external trigger source between negative (EXTN) and positive (EXTP). This command is valid only when an external trigger source is properly connected and enabled.

If you have select EXT (an external trigger source), the query returns the current slope of the external trigger

source. If you have NOT select EXT or you preset the signal generator, the query returns “NA”.

Range	EXTN, EXTP
*RST value	NA
Returned data	EXTN, EXTP, NA
Front panel access	Sweep > Sweep Trigger > Trigger In Neg/Pos

Point Trigger

```
:SWEep:PTRG IMMEDIATE|KEY|EXT
```

```
:SWEep:PTRG?
```

This command sets the point trigger mode to one of the following items:

- IMMEDIATE - immediately initiates a sweep.
- KEY - arms a sweep and requires you to send the command “TRIGger:IMMEDIATE”
- EXT - enables an external trigger source to initiate each point in a sweep.

The query returns the current sweep trigger mode.

Range	IMMEDIATE, KEY, EXT
*RST value	IMMEDIATE
Returned data	IMM, KEY, EXT
Front panel access	Sweep > Point Trigger

External Point Trigger Slope

```
:SWEep:PTRG:SLOPe EXTN|EXTP
:SWEep:PTRG:SLOPe?
```

This command toggles the slope of external trigger source between negative (EXTN) and positive (EXTP). This command is valid only when an external trigger source is properly connected and enabled.

If you have selected EXT (an external trigger source), the query returns the current slope of the external trigger source. If you have NOT selected EXT or you preset the signal generator, the query returns "NA".

Range	EXTN, EXTP
*RST value	NA
Returned data	EXTN, EXTP, NA
Front panel access	Sweep > Point Trigger > Trigger In Neg/Pos

Sweep Direction

```
:SWEep:DIRection UP|DOWN
:SWEep:DIRection?
```

This command sets the sweep direction of an RF, LF or an amplitude sweep to either of the following choices:

- UP - sweeps from start point to stop point
- Down - sweeps from stop point to start point

The query returns the current sweep direction.

Range	UP, DOWN
*RST value	UP
Returned data	UP, DOWN
Front panel access	Sweep > Sweep Direction

AM Subsystem

The AM subsystem controls the settings and parameters associated with amplitude modulated signal.

AM State

```
:AM:STATE ON|OFF|1|0
```

```
:AM:STATE?
```

This command toggles the AM state between ON and OFF. However, applying an amplitude modulation to the RF carrier requires you also set MOD on.

See “[Modulation State Subsystem](#)” on page 145.

The query returns the current AM state.

Range	ON(1), OFF(0)
*RST value	OFF
Returned data	1, 0
Front panel access	AM > AM On/Off

AM Depth

:AM:DEPTH <val>

:AM:DEPTH?

This command sets the amplitude modulation depth.

The query returns the current AM depth.

Range	0 to 100
Minimum increment	0.1
*RST value	0.0 %
Returned data	<val>
Front panel access	AM > AM Depth

AM Rate

:AM:RATE <val> <unit>

:AM:RATE?

This command sets the frequency of the internal AM source. The query returns the current frequency of the internal AM source.

Range	20 Hz to 80 kHz
Minimum increment	0.1 Hz
*RST value	1.0000 kHz
Returned data format	<val> <unit>
Front panel access	AM > AM Rate

AM Source

```
:AM:SOURce INT|EXT|INT+EXT
```

```
:AM:SOURce?
```

This command sets the AM source to one of the three choices: internal source, external source or combined internal and external source.

The query returns the current AM source.

Range	INT, EXT, INT+EXT
*RST value	INT
Returned data	INT, EXT, INT+EXT
Front panel access	AM > AM Source

AM External Coupling

```
:AM:EXTCoupling AC|DC
```

```
:AM:EXTCoupling?
```

This command sets the coupling for the external AM source. The choice is either AC or DC coupling. AC coupling passes only AC signal components. DC coupling passes both the AC and DC signal components. This command is effective only when an external AM source is connected and enabled.

The query returns the current external coupling state.

Range	AC, DC
*RST value	AC
Returned data	AC, DC
Front panel access	AM > EXT Coupling

FM Subsystem

The FM subsystem controls the settings and parameters associated with frequency modulated signal.

FM State

```
:FM:STATE ON|OFF|1|0
```

```
:FM:STATE?
```

This command toggles the FM state between ON and OFF. However, applying a frequency modulation to the RF carrier requires you also set MOD on.

See “[Modulation State Subsystem](#)” on page 145

The query returns the current FM state.

Range	ON (1), OFF (0)
*RST value	OFF
Returned data	1, 0
Front panel access	FM > FM On/Off

FM Deviation

```
:FM:DEVIation <val> <unit>
```

```
:FM:DEVIation?
```

This command sets the FM deviation.

The query returns the current FM deviation.

Range	20 Hz to 100 kHz
Valid unit	kHz, Hz
Minimum increment	1 Hz
*RST value	20 Hz
Returned data format	<val> <unit>
Front panel access	FM > FM Deviation

FM Rate

```
:FM:RATE <val> <unit>
```

```
:FM:RATE?
```

This command sets the frequency of the internal FM source.

The query returns the current frequency of the internal FM source.

Range	20 Hz to 80 kHz
Minimum increment	0.1 Hz
*RST value	1.0000 kHz
Returned data format	<val> <unit>
Front panel access	FM > FM Rate

FM Source

```
:FM:SOURce INT|EXT|INT+EXT
:FM:SOURce?
```

This command sets the FM source to one of the three choices: internal source, external source or combined internal and external source.

The query returns the current FM source.

Range	INT, EXT, INT+EXT
*RST value	INT
Returned data format	INT, EXT, INT+EXT
Front panel access	FM > FM Source

FM External Coupling

```
:FM:EXTCoupling AC|DC
:FM:EXTCoupling?
```

This command sets the coupling for the external FM source. The choice is either AC or DC coupling. AC coupling passes only AC signal components. DC coupling passes both the AC and DC signal components.

This command is effective only when an external FM source is connected and enabled.

The query returns the current external coupling state.

Range	AC, DC
*RST value	AC
Returned data	AC, DC
Front panel access	FM > EXT Coupling

Phase Modulation Subsystem

The phase modulation (Φ M) subsystem controls the settings and parameters associated with phase modulated signal.

Φ M State

```
:PM:STATE ON|OFF|1|0
```

```
:PM:STATE?
```

This command toggles the Φ M state between ON and OFF. However, applying a phase modulation to the RF carrier requires you also set MOD on. See “[Modulation State Subsystem](#)” on page 145.

The query returns the current Φ M state.

Range	ON (1) / OFF (0)
*RST value	OFF
Returned data	1, 0
Front panel access	Φ M > Φ M On/Off

ΦM Deviation

:PM:DEVIation <val> <unit>

:PM:DEVIation?

This command sets the ΦM deviation.

Choices for the variables <val> depend on ΦM rate.

The query returns the current ΦM deviation.

Range	0 to 10 rad (300 Hz ≤ ΦM rate ≤ 10 kHz) 0 to 5 rad (10 kHz < ΦM rate ≤ 20 kHz)
Valid unit	rad
Minimum increment	0.001 rad
*RST value	0.000 rad
Returned data format	<val> <unit>
Front panel access	ΦM > ΦM Deviation

ΦM Rate

:PM:RATE <val> <unit>

:PM:RATE?

This command sets the frequency of the internal ΦM source. The query returns the current frequency of the internal ΦM source.

Range	300 Hz to 80 kHz
Minimum increment	0.1 Hz
*RST value	1.0000 kHz
Returned data format	<val> <unit>
Front panel access	ΦM > ΦM Rate

Pulse Modulation Subsystem

The phase modulation (Φ M) subsystem controls the settings and parameters associated with phase modulated signal.

Pulse Modulation State

```
:PULM:STATe ON|OFF|1|0
```

```
:PULM:STATe?
```

This command toggles the pulse modulation state between ON and OFF.

The query returns the current pulse modulation state.

Range	ON(1), OFF(0)
*RST value	OFF
Returned data	1, 0
Front panel access	Pulse > Pulse On/Off

Pulse Source

```
:PULM:SOURce INT|EXT
```

```
:PULM:SOURce?
```

This command sets the pulse source to either internal or external source.

The query returns the current pulse modulation source.

Range	INT, EXT
*RST value	INT
Returned data	INT, EXT
Front panel access	Pulse > Pulse Source

Pulse Period

```
:PULM:WIDTh <val> <unit>
```

```
:PULM:WIDTh?
```

This command sets the pulse period of the internally generated pulse modulation signal.

The query returns the current pulse period of the internal pulse source.

Range	200 μ s to 2s
Valid unit	s, ms, us
Minimum increment	1 us
*RST value	200 us
Returned data format	<val> <unit>
Front panel access	Pulse > Pulse Period

Pulse Width

```
:PULM:PERiod <val> <unit>
```

```
:PULM:PERiod?
```

This command sets the pulse width of the internally generated pulse modulation signal.

The query returns the current pulse width of the internal pulse source.

Range	100 us to 1s
Valid unit	s, ms, us
Minimum increment	1 us
*RST value	100 us
Returned data format	<val> <unit>
Front panel access	Pulse > Pulse Width

I/Q Modulation Subsystem

The I/Q modulation subsystem controls I/Q modulation.

Enable I/Q Modulation

```
:IQ:STATE ON|OFF|1|0
```

```
:IQ:STATE?
```

This command toggles the externally generated I/Q modulation state between ON and OFF.

The external I/Q signal must meet the following restrictions, before you enable the I/Q modulation:

- input impedance 50 Ω
- VSWR < 1.5
- Full scale input voltage < 0.5 V_{rms}

The query returns the current state of I/Q modulation.

Range	ON (1), OFF (0)
*RST value	OFF
Returned data	1, 0
Front panel access	I/Q > I/Q On/Off

Utility Subsystem

The commands of the utility subsystem control the settings and parameters associated with the signal generator's system configurations.

Display Style

```
:SYSTem:DISPlay WHITE|BLUE|GREEN
```

```
:SYSTem:DISPlay?
```

This command sets the display style to any of the following three choices: classic white, modern blue or jade green.

The query returns the current display style in use.

Range	WHITE, BLUE, GREEN
*RST value	BLUE
Returned data	WHITE, BLUE, GREEN
Front panel access	Utility > Display Style

Error Messages

```
:SYSTem:ERRor?
```

This is a query only command.

It returns the a decimal value that indicates the error message code number. To interpret the error code number, please refer to [“Instrument Messages”](#) on page 171.

Screen Saver

```
:SYSTem:SSAVer ON|OFF|1|0
```

```
:SYSTem:SSAVer?
```

This command toggles the screen saver between On and Off.

If you set the screen saver On, the signal generator turns off its screen after standing by for 15 minutes. Pressing **Local** hardkey turns on screen but also returns the signal generator to Local Control.

The query returns the current screen saver state.

Range	ON (1) , OFF (0)
*RST value	OFF
Returned data	1, 0
Front panel access	Utility > Screen Saver

System Date

```
:SYSTem:DATE <year><month><day>
```

```
:SYSTem:DATE?
```

This command sets the date in the signal generator. Do NOT put a space or comma between the variables <year><month><day>.

The query returns the current date in the signal generator.

Range	<ul style="list-style-type: none"> • Year: 1980 to 2030, four-digit numeric type (YYYY) • Month: 01 to 12, two-digit numeric type (MM) • Day: 01 to 31, two-digit numeric type (DD)
Returned data	<year><month><day>
Front panel access	Utility > Date/Time > Set Date

System Time

```
:SYSTem:TIME <hour><minute>
```

```
:SYSTem:TIME?
```

This command sets time on the signal generator. Do NOT put a space or comma between the variables <hour><minute>.

The query returns the current time in the signal generator.

Range	<ul style="list-style-type: none"> Hour: 00 to 23, two-digit numeric type numeric (HH) Minute: 0 to 59, two-digit numeric type numeric (MM)
--------------	---

Returned data	<hour><minute><second>
----------------------	------------------------

Front panel access	Utility > Date/Time > Set Time
---------------------------	---

Reference Oscillator Sources

```
:SYSTem:REfERENCE:FREQuency
```

```
INT10MHZ | EXT2MHZ | EXT5MHZ | EXT10MHZ
```

```
:SYSTem:REfERENCE:FREQuency?
```

This command sets the reference oscillator to any of the four choices:

- internal 10 MHz reference oscillator
- external 2 MHz reference oscillator
- external 5 MHz reference oscillator
- external 10 MHz reference oscillator

The query returns the current reference source.

Range	INT10MHZ, EXT2MHZ, EXT5MHZ, EXT10MHZ
--------------	--------------------------------------

*RST value	INT10MHZ
-------------------	----------

Returned data	INT10MHZ, EXT2MHZ, EXT5MHZ, EXT10MHZ
----------------------	--------------------------------------

Front panel access	Utility > Ref Setups
---------------------------	--------------------------------

Phase Noise Mode

:SYSTem:PNMD NORMAL|RESFM

:SYSTem:PNMD?

This command sets the phase noise mode to either normal mode or optimized residual FM mode (RESFM) .

Range	NORMAL, RESFM
*RST value	NORMAL
Returned data	NORMAL, RESFM
Front panel access	Utility > Opt. Φ Noise

Modulation State Subsystem

```
:MOD:STATE ON|OFF|1|0
```

```
:MOD:STATE?
```

This command enables or disables the modulator.

The query returns the current modulator state.

Range	ON (1), OFF (0)
*RST value	ON
Returned data	1, 0
Front panel access	MOD On/Off

RF Output State Subsystem

```
:RFOutput:STATE ON|OFF|1|0
```

```
:RFOutput:STATE?
```

This command enables or disables the RF output.

The query returns the current RF output state.

Range	ON (1), OFF (0)
*RST value	OFF
Returned data	1, 0
Front panel access	RF On/Off

LF Output Subsystem

The low frequency (LF) subsystem controls the settings and parameters of an LF output signal.

LF Output State

```
:LFOutput:STATE ON|OFF|1|0
```

```
:LFOutput:STATE?
```

This command enables or disables the LF signal output. The query returns the current state of LF output signal.

Range	ON(1), OFF(0)
*RST value	OFF
Returned data	1, 0
Front panel access	LF Out > LF Out On/Off

LF Output Frequency

```
:LFOutput:FREQuency <val> <unit>
```

```
:LFOutput:FREQuency?
```

This command sets the LF output frequency.

The query returns the current LF signal frequency.

Range	20 Hz to 80 kHz
Valid unit	kHz, Hz
Resolution	0.1 Hz
*RST value	1.0000 kHz
Returned data format	<val> <unit>
Front panel access	LF Out > LF Out Freq

LF Output Amplitude

```
:LFOutput:AMPLitude <val> <unit>
```

```
:LFOutput:AMPLitude?
```

This command sets the LF output amplitude.

The query returns the current LF output amplitude.

Range	0 to 3 V
Valid unit	V, mV
Resolution	1 mV
*RST value	500 mV
Returned data format	<val> <unit>
Front panel access	LF Out > LF Out Ampl

Subsystem Command Trees

Subsystem command trees help you to understand command syntax and the hierachical structure of each command in a subsystem.

Symbols used in Command Trees

Symbol	Caption	Utility
:	Colon	Separates different level keywords
Ⓢ	Space	Separates parameters from keywords and also separates parameters from their units
value	Numeric parameter	Requires you to customize an exact number for the variable
A B	Enumerative or Boolean parameter	Requires you to select a parameter from the list
unit	Unit	use along with numeric parameter
RF	Key word	mnemonics of different levels

Frequency Subsystem

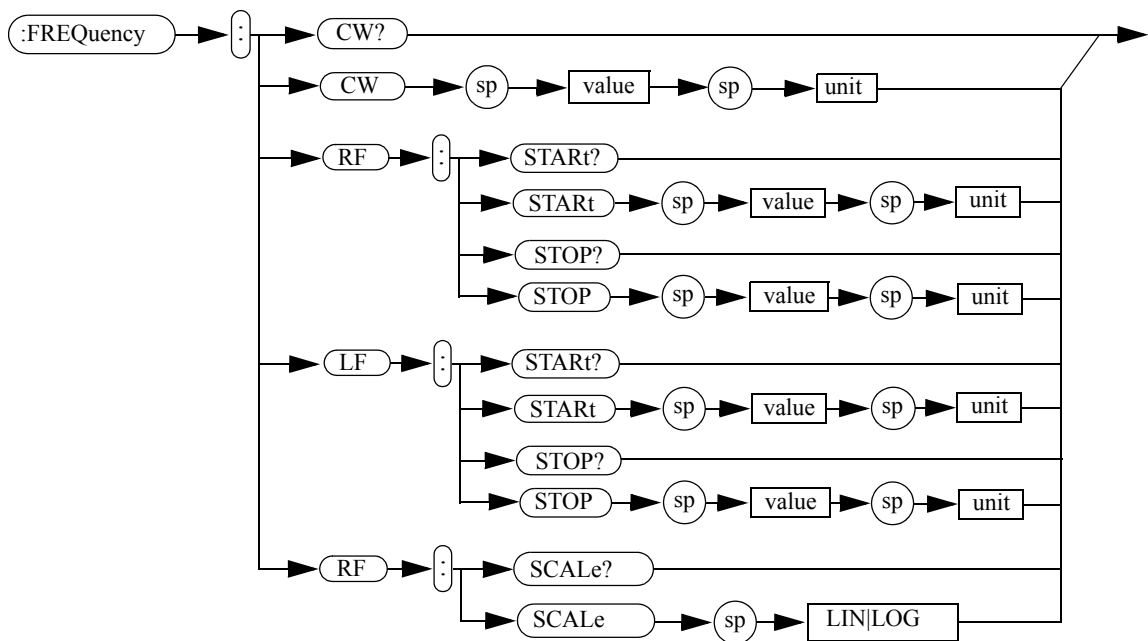

Amplitude Subsystem

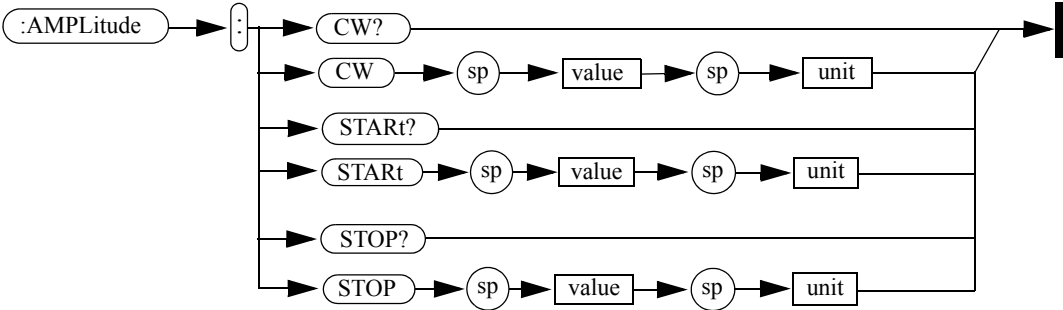

Trigger Subsystem

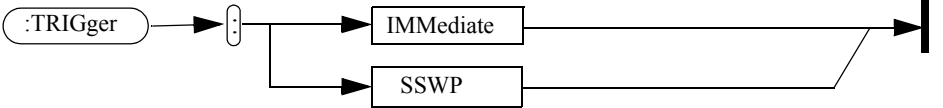

LF Output Subsystem

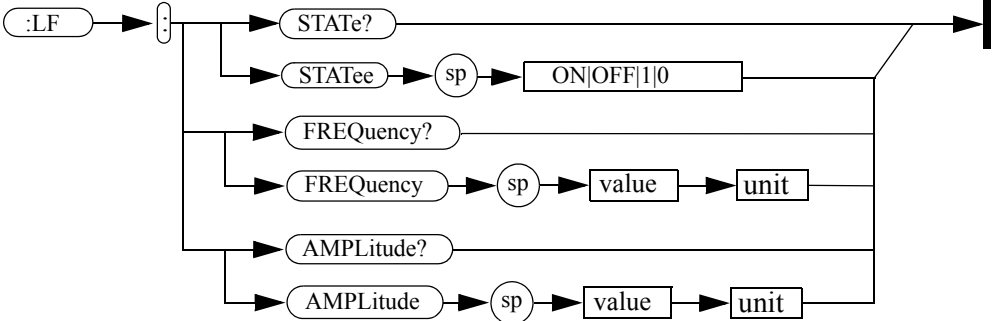

Sweep Subsystem

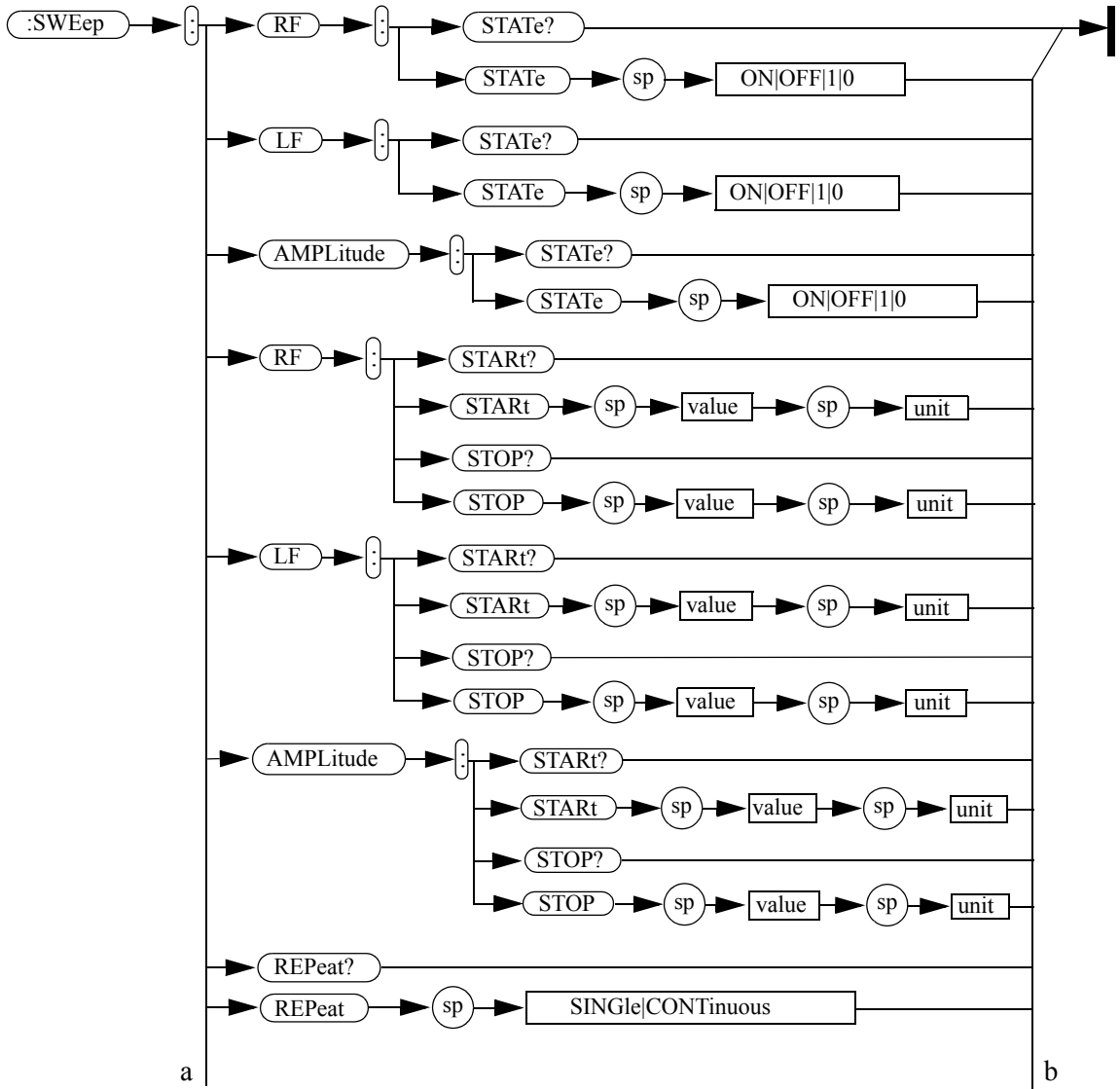

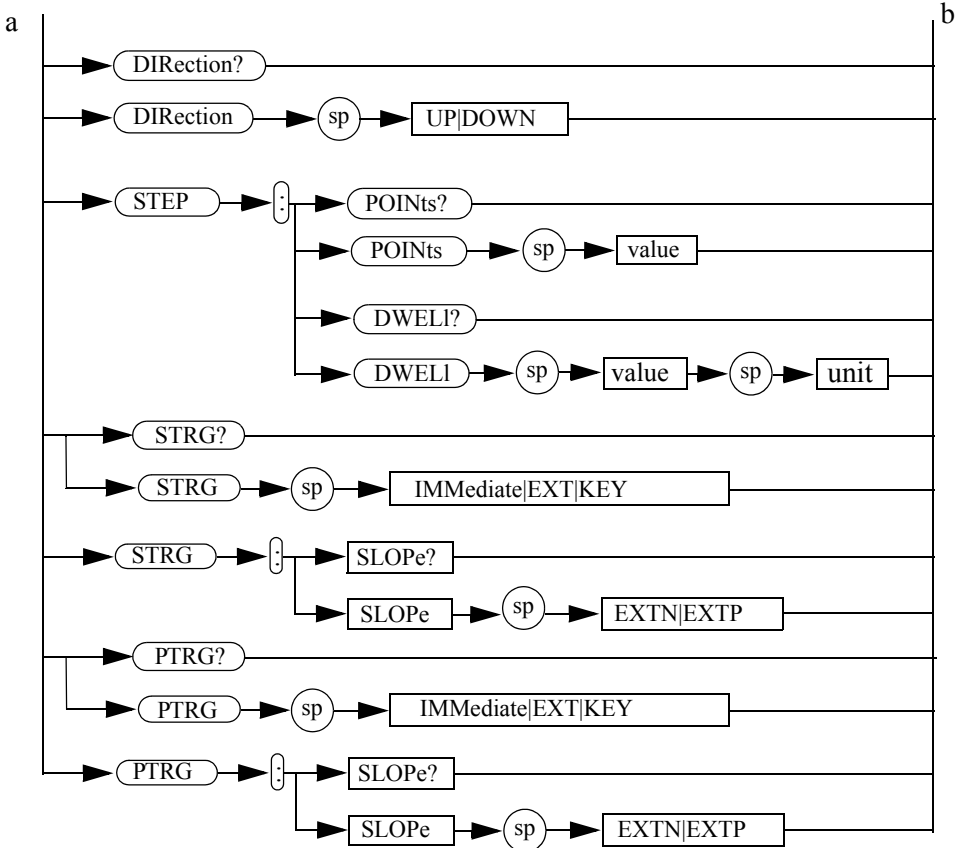

AM Subsystem

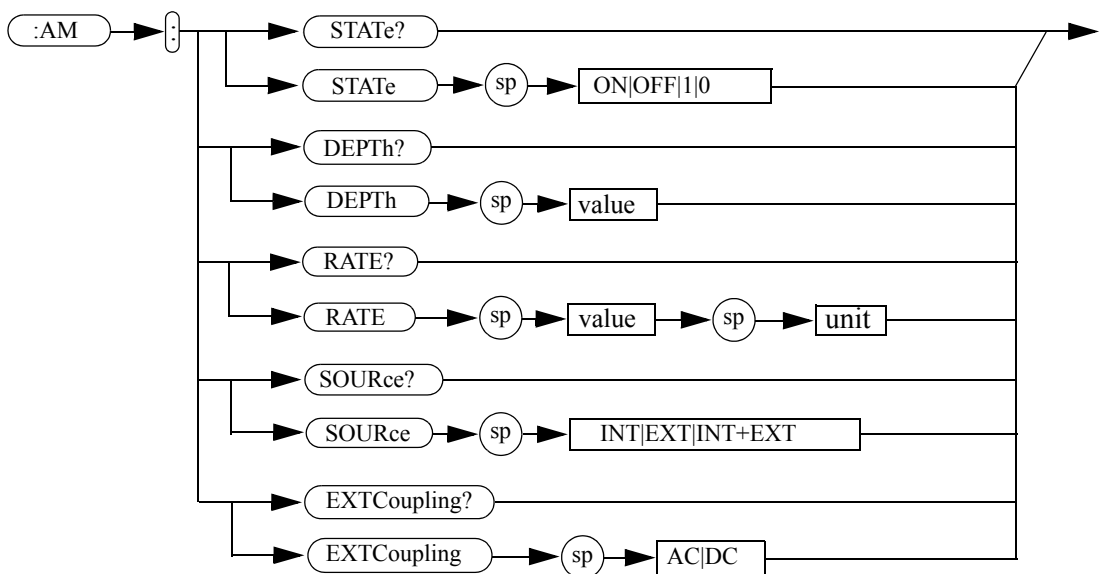

FM Subsystem

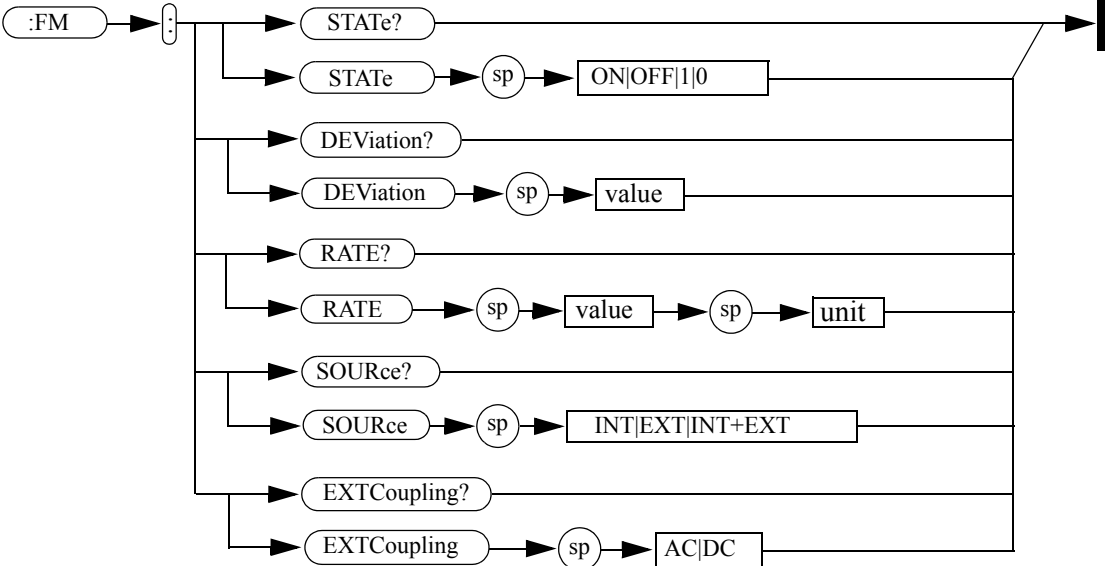

Phase Modulation Subsystem

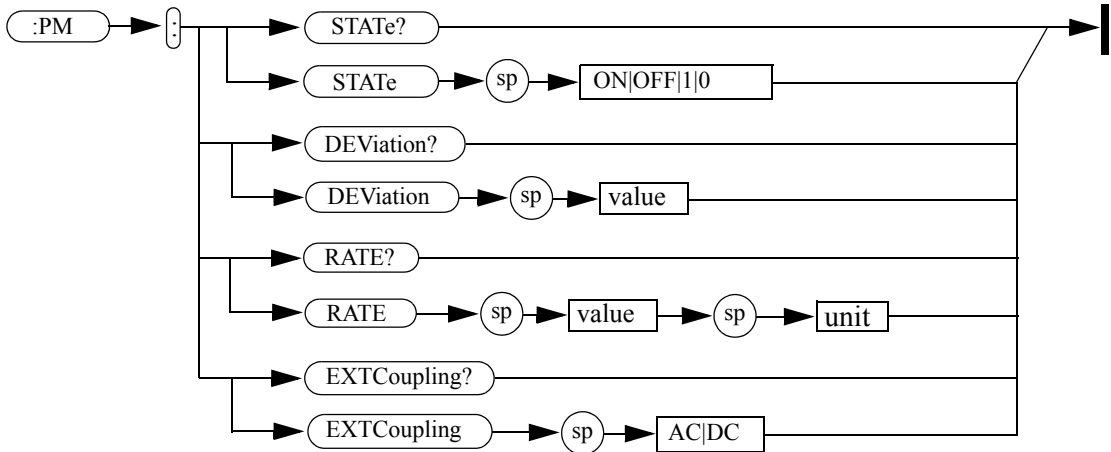

Pulse Modulation Subsystem

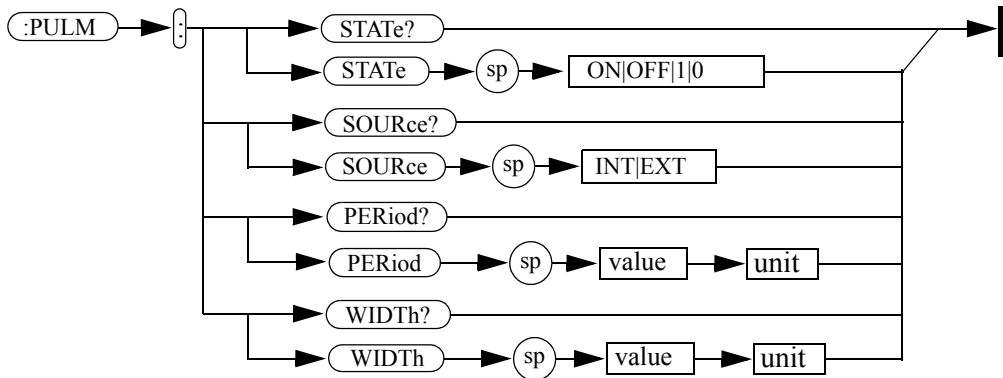

I/Q Modulation Subsystem

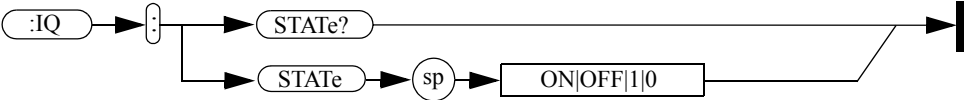

Modulation State Subsystem

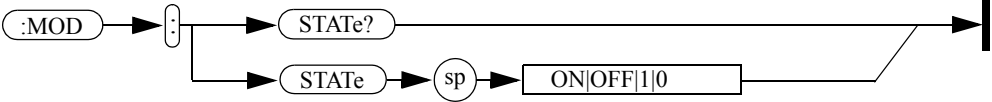

RF Output State Subsystem

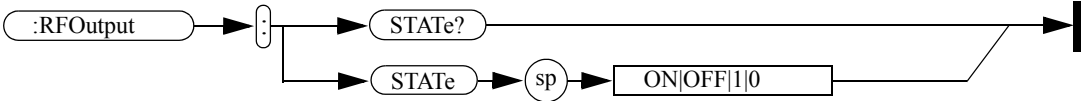

Utility Subsystem

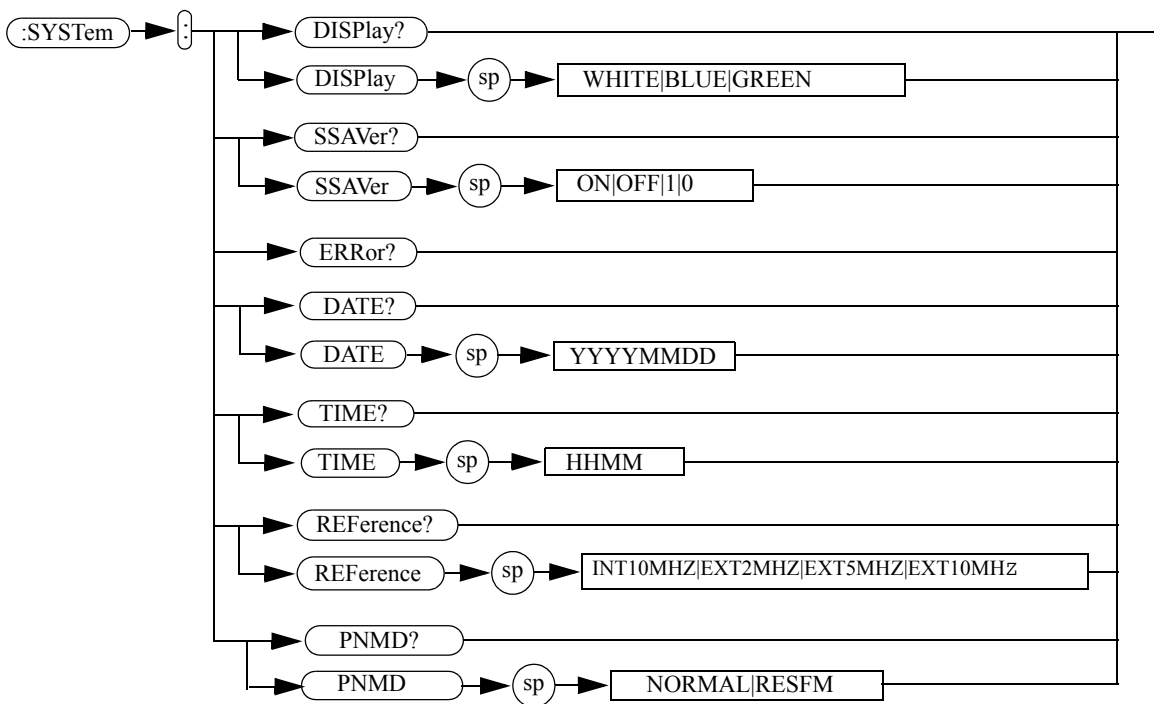

Programming Examples

The programming examples in this section keep to the following 3 conventions:

- The programming examples were written for use on an IBM compatible PC.
- The programming examples use USB interface
- The programming examples are written in C programming language and SCPI programming commands, using Agilent VISA transition library (Agilent VTL).

The Agilent VTL is installed when you installed the Agilent IO libraries suite.

The Agilent IO libraries suite contains the latest Agilent VTL and is available at:

<http://www.agilent.com/find/iolib>

NOTE

Agilent Technology provides programming examples for illustration only. All sample programs assume that you are familiar with the programming language being demonstrated and the tools used to create and debug procedures.

You have a royalty-free right to use, modify, reproduce and distribute the sample application files in any way you find useful, provided that you agree that Agilent has no warranty, obligations, or liability for any sample application files.

Programming in C using the VTL

This section includes some basic information about programming in the C language using Agilent VISA transition library (VTL). Note that some of this information may not be relevant to your particular application. For example, if you are not using VXI instruments, the VXI references will not be relevant.

Typical Example Program Contents

The following table summaries the VTL function calls used in the example programs.

visa.h	This file is included at the beginning of the each file to provide the function prototypes and constants defined by VTL. For C and C++ programs, you must include the <code>visa.h</code> header file at the beginning of every file that contains VISA function calls: <code>#include "visa.h"</code>
ViSession	The <code>ViSession</code> is a VTL data type. Each object that will establish a communication channel must be defined as <code>ViSession</code> . Sessions must firstly be opened on the default resource manager, and then for each resource you will be using.
viOpenDefaultRM	You must first open a session with the default resource manager with the <code>viOpenDefaultRM</code> function, and then for each resource you will be using. This function will initialize the default resource manager and return a pointer to that resource manager session. <code>viOpenDefaultRM(&sesn)</code>

viOpen	<p>This function establishes a communication channel with the device specified. A session identifier that can be used with other VTL functions is returned. This call must be made for each device you will be using.</p> <pre>viOpenDefaultRM(&sesn) viOpen(sesn, rsrcName, accessMode, timeout, &vi)</pre>
viWrite	<p>This function synchronously sends the data pointed to by buf to the device specified by vi. Only one synchronous write operation can occur at any one time.</p> <pre>viWrite(vi, buf, count, &retCount)</pre>
viRead	<p>This function synchronously reads raw data from the session specified by the vi parameter and stores the result in location where buf is pointing. Only one synchronous read operation can occur at any one time.</p> <pre>viRead(vi, buf, count, &retCount)</pre>
viClose	<p>This function must be used to close each session. When you close a device session, all data structures that had been allocated for the session will be set free. If you close the default resource manager session, all sessions opened using that resource manager session will be closed.</p> <pre>viClose(vi); viClose(defaultRM)</pre>

Example 1 - Checking USB Connection

Usually, using “*IDN?” verifies the data transferring between the controller PC and the instrument.

```
*****
#include "visa.h"
#include <studio.h>

#define BufferSize 128

static Vistatus status;
static ViSession defaultRM;
static ViSession inst_N9310A;
static ViUInt32 rcount;
static unsigned char buffer[BufferSize];

int main(void)
{
/* Connect N9310A and read its "IDN". */
status = viOpen (defaultRM,
"USB0::2391::8216::0115000001::0::INSTR", VI_NULL,
VI_NULL, &inst_N9310A);
if (STATUS != VI_SUCCESS);
return -1; //failed to connect N9310A

/* Read "IDN" from N9310A" */
status = viWrite (inst_N9310A, "*RST\n",
StringLength("*RST\n", &rcount);
status = viWrite (inst_N9310A, "*IDN?\n",
StringLength("*IDN?\n"), &rcount);
status = viRead (inst_N9310A, buffer, BufferSize,
&rcount);

/* Close connection to N9310A. */
status = viClose (inst_N9310A);
status = viClose (defaultRM); return 1;
}

```

Programming Comments

Thread	Relevant code
Include the visa.h header file at the beginning of every file that contains VTL function calls.	<code>#include "visa.h"</code>
Open a session on the default resource manager first, and then for the device you will be using.	<code>viOpenDefaultRM (&defaultRM) viOpen (defaultRM, "USB0::2391::8216::0115000001::0::INSTR", VI_NULL, VI_NULL, &inst_N9310A)</code>
Send a *RST command to set the instrument to its default status.	<code>viWrite (inst_N9310A, "*RST\n", StringLength ("*RST\n"), &rcount)</code>
Send a *IDN? query to the instrument.	<code>viWrite (inst_N9310A, "*IDN?\n", StringLength ("*IDN?\n"), &rcount)</code>
Fetch the instrument identity information to the buffer.	<code>viRead (inst_N9310A, buffer, BufferSize, &rcount)</code>
Close device session	<code>viClose (inst_N9310A) viClose (defaultRM)</code>

Example 2 - Generating a CW signal

Assume you wish to generate a CW signal with a frequency of 1 GHz and an amplitude of -10 dBm.

```
*****
int main(void)
{
    status = viOpenDefaultRM (&defaultRM);
    if (status != VI_SUCCESS) return -1;

    status = viOpen (defaultRM,
        "USB0::2391::8216::0115000001::0::INSTR", VI_NULL,
        VI_NULL, &INST_N9310A);
    if (status != VI_SUCCESS) return -1;

    /* Setup N9310A to generate a CW wave. */
    status = viWrite (inst_N9310A, "*RST\n",
        StringLength("*RST\n"), &rcount)

    status = viWrite (inst_N9310A, "FREQ:CW 1 GHz\n",
        StringLength("FREQ:CW 1 GHz\n"), &rcount);

    status = viWrite (inst_N9310A, "AMPL:CW -10 dBm\n",
        StringLength("AMPL:CW -10 dBm\n"), &rcount);

    status = viWrite (inst_N9310A, "RFO:STAT ON\n",
        StringLength("RFO:STAT ON\n"), &rcount);

    staus = viClose (inst_N9310A);
    status = viClose (defaultRM)

    return 1;
}
```

Programming Comments

Thread	Relevant code
Open a session on the default resource manager first, and then for the device you will be using.	<pre>viOpenDefaultRM (&defaultRM) viOpen (defaultRM, "USB0::2391::8216::0115000001::0::INSTR", VI_NULL, VI_NULL, &inst_N9310A)</pre>
Preset the signal generator	<pre>viWrite (inst_N9310A, "*RST\n", StringLength("*RST\n"), &rcount)</pre>
Set the frequency and amplitude of the CW signal	<pre>status = viWrite (inst_N9310A, "FREQ:CW 1 GHz\n", StringLength("FREQ:CW 1 GHz\n"), &rcount); status = viWrite (inst_N9310A, "AMPL:CW -10 dBm\n", StringLength("AMPL:CW -10 dBm\ n"), &rcount);</pre>
Enable the RF output	<pre>viWrite (inst_N9310A, "RFO:STAT ON\n", StringLength("RFO:STAT ON\n"), &rcount);</pre>
Close device session	<pre>viClose (inst_N9310A) viClose (defaultRM)</pre>

Example 3 - Generating an AM Signal

Assume you wish to generate an AM signal, with the following characters:

- AM depth = 80 %
- AM rate = 10 kHz
- AM source = internal source
- CW. frequency = 1 GHz
- CW. amplitude = -10 dBm

```
*****
/* Setup N9310A to generate an AM wave. */
int main(void)
{
    status = viOpenDefaultRM (&defaultRM);
    if (status != VI_SUCCESS) return -1;

    status = viOpen (defaultRM,
        "USB0::2391::8216::0115000001::0::INSTR", VI_NULL,
        VI_NULL, &INST_N9310A);
    if (status != VI_SUCCESS) return -1;

    /* Configure the carrier. */
    status = viWrite (inst_N9310A, "*RST\n",
        StringLength("*RST\n"), &rcount);

    status = viWrite (inst_N9310A, "FREQ:CW 1 GHz\n",
        StringLength("FREQ:CW 1 GHz\n"), &rcount);

    status = viWrite (inst_N9310A, "AMPL:CW -10 dBm\n",
        StringLength("AMPL:CW -10 dBm\n"), &rcount);

    /* Configure the AM. */
    status = viWrite (inst_N9310A, "AM:DEPT 80\n",
        StringLength("AM:DEPT 80\n"), &rcount);

    status = viWrite (inst_N9310A, "AM:RATE 10 kHz\n",
        StringLength("AM:RATE 10 kHz\n"), &rcount);

    /* Enable AM and RF output. */
    status = viWrite (inst_N9310A, "AM:STAT ON\n",
        StringLength("AM:STAT ON\n"), &rcount);
}
```

```

status = viWrite (inst_N9310A, "RFO:STAT ON\n",
StringLength("RFO:STAT:ON"\n, &rcount);
/* Close session. */
staus = viClose (inst_N9310A);
status = viClose (defaultRM)
return 1;
}

```

Programming Comments

Thread	Relevant code
Open a session on the default resource manager first, and then for the device you will be using.	<pre> viOpenDefaultRM (&defaultRM) viOpen (defaultRM, "USB0::2391::8216::0115000001::0::INSTR", VI_NULL, VI_NULL, &inst_N9310A) </pre>
Preset the signal generator	<pre> viWrite (inst_N9310A, "*RST\n", StringLength("*RST\n"), &rcount) </pre>
Set the frequency and amplitude of the CW signal	<pre> viWrite (inst_N9310A, "FREQ:CW 1 GHz\n", StringLength("FREQ:CW 1 GHz\n"), &rcount) viWrite (inst_N9310A, "AMPL:CW -10 dBm\n", StringLength("AMPL:CW -10 dBm\n"), &rcount) </pre>
Set AM depth and AM rate	<pre> viWrite (inst_N9310A, "AM:DEPT 80\n", StringLength("AM:DEPT 80\n"), &rcount) viWrite (inst_N9310A, "AM:RATE 10 kHz\n", StringLength("AM:RATE 10 kHz\n"), &rcount) </pre>
Enable AM	<pre> viWrite (inst_N9310A, "AM:STAT ON\n", StringLength("AM:STAT:ON\n"), &rcount) </pre>
Enable the RF output	<pre> viWrite (inst_N9310A, "RFO:STAT ON\n", StringLength("RFO:STAT:ON\n"), &rcount) </pre>
Close device session	<pre> viClose (inst_N9310A) viClose (defaultRM) </pre>

NOTE

After presetting the signal generator, the AM source is set to internal source and the modulation state is set to On by default. The commands to set the AM source and the Modulation state are omitted in this example.

Example 4 - Generating an continuous RF Sweep

Assume you wish to initiate an RF sweep, with the following characters:

- RF sweeps from 1 GHz to 2 GHz
- Sweeps across 90 points linearly
- Dwells for 20 ms for each point
- Repeats sweep continuously
- Triggers immediately and continuously over all points

```

/* Setup N9310A to generate an continuous RF
output. */
int main(void)
{
status = viOpenDefaultRM (&defaultRM);
if (status != VI_SUCCESS) return -1;
status = viOpen (defaultRM,
"USB0::2391::8216::0115000001::0::INSTR", VI_NULL,
VI_NULL, &INST_N9310A);
if (status != VI_SUCCESS) return -1;
/* Configure an RF sweep. */
status = viWrite (inst_N9310A, "*RST\n",
StringLength("*RST\n"), &rcount);
status = viWrite (inst_N9310A, "SWE:RF:STAR 1 GHz\n",
StringLength("SWE:RF:STAR 1 GHz\n"), &rcount);
status = viWrite (inst_N9310A, "SWE:RF:STOP 2 GHz\n",
StringLength("SWE:RF:STOP 2 GHz\n"), &rcount);
status = viWrite (inst_N9310A, "SWE:STEP:POIN 90\n",
StringLength("SWE:STEP:POIN 90\n"), &rcount);
status = viWrite (inst_N9310A, "SWE:STEP:DWEL 20
ms\n", StringLength("SWE:STEP:DWEL 20 ms\n"),
&rcount);
/* Enable RF sweep & initiate the RF sweep. */
status = viWrite (inst_N9310A, "RFO:STAT ON\n",
StringLength("RFO:STAT ON\n"), &rcount);

```

```

status = viWrite (inst_N9310A, "SWE:RF:STAT ON\n",
StringLength("SWE:RF:STAT ON\n"), &rcount);
/* Close session. */
status = viClose (inst_N9310A);
status = viClose (defaultRM);
return 1;
}

```

Programming Comments

Thread	Relevant code
Open a session on the default resource manager first, and then for the device you will be using.	<pre> viOpenDefaultRM (&defaultRM) viOpen (defaultRM, "USB0::2391::8216::0115000001::0::INSTR", VI_NULL, VI_NULL, &inst_N9310A) </pre>
Preset the signal generator	<pre> viWrite (inst_N9310A, "*RST\n", StringLength("*RST\n"), &rcount) </pre>
Set the start frequency and the stop frequency	<pre> viWrite (inst_N9310A, "SWE:RF:STAR 1 GHz\n", StringLength("SWE:RF:STAR 1 GHz\n"), &rcount) viWrite (inst_N9310A, "SWE:RF:STOP 2 GHz\n", StringLength("SWE:RF:STOP 2 GHz\n"), &rcount) </pre>
Set the number of points and dwell time for each point	<pre> viWrite (inst_N9310A, "SWE:STEP:POIN 90\n", StringLength("SWE:STEP:POIN 90\n"), &rcount) viWrite (inst_N9310A, "SWE:STEP:DWEL 20 ms\n", StringLength("SWE:STEP:DWEL 20 ms\n"), &rcount) </pre>
Enable RF output	<pre> viWrite (inst_N9310A, "RFO:STAT ON\n", StringLength("RFO:STAT ON\n"), &rcount) </pre>
Enable RF sweep	<pre> viWrite (inst_N9310A, "SWE:RF:STAT ON\n", StringLength("SWE:RF:STAT ON\n"), &rcount) </pre>
Close device session	<pre> viClose (inst_N9310A) viClose (defaultRM) </pre>

NOTE

After presetting the signal generator, the Sweep Repeat is set to CONT, Sweep Direction is set to UP and Sweep trigger and Point trigger is set to IMMEDIATE by default. The commands to set the Sweep Repeat, Sweep Direction, Sweep trigger and Point trigger are omitted in this example.



7 Instrument Messages

Overview	172
Command Errors	173
Execution Conflict	176
System Errors	177
Hardware Errors	178



Overview

The instrument messages include system messages and error messages.

System messages

If an improper operation occurs during the instrument configuration, a system message displays in the text area of the screen, indicating the incident and the how the signal generator corrected the setting automatically. The system messages will be cleared automatically 30 seconds later.

Error messages

If a system error or a hardware error occurs, the error messages will appear on the screen and an ERR annunciator displays also on the screen. Then you need to press  > **Error Info** to read the specific descriptions of those error messages.

Example

In this example, an explanation is generally included with each error to further clarify its meaning. The instrument messages in this guide are listed numerically.

<Code>

-222

Data out of range;

<Message>

Value clipped to lower limit.

<Description>

Indicates that the user has entered a deviation, depth or internal source frequency that is beyond the specified limits.

<Explanation in manual>

Command Errors

The messages listed below are command errors, which are saved into local registers. Press  > **Error Info** to read or delete them.

- 100 Command error;
An unrecognized command or data type was encountered. This message is used when the device cannot detect more specifics described for errors -101 to -109.

- 101 Invalid character;
A syntactic element contains an invalid character.

- 102 Syntax error;
An unrecognized command or data type was encountered.

- 103 Invalid separator;
The parser recognized a separator that is not allowed.

- 108 Parameter not allowed;
More parameters were received than expected for the header.

- 109 Missing parameter;
Fewer parameters were received than required for the header.

- 110 Command header error;
An error was detected in the header. This message is used when the device cannot detect more specifics described for errors -111 to -119.

7 Instrument Messages

- 111 Header separator error;
A character that is not a legal header separator was encountered while parsing the header.

- 112 Program mnemonic too long;
The header contains more than 12 characters.

- 113 Undefined header;
The header is correct in syntax, but it is undefined for this device.

- 120 Numeric data error;
An error occurred when parsing a data element that appears to be numeric including non-decimal numeric types. Specific details are not available.

- 121 Invalid character in numeric;
An invalid character for the data type being parsed was encountered.

- 124 Too many digits;
The mantissa of a decimal-numeric data element contained more than 20 digits excluding leading zeros.

- 128 Numeric data not allowed;
A legal numeric data element was received, but the device does not accept one in this position for the header.

- 130 Suffix error;

This error is generated when parsing a suffix. This message is used when the device cannot detect more specifics described for errors -101 to -109.

- 131 Invalid suffix;
The suffix does not follow the syntax described in *IEEE 488.2*, or the suffix is inappropriate for the device.

- 134 Suffix too long;
The suffix contained more than 12 characters.

- 138 Suffix not allowed;
A suffix was encountered after a numeric element which does not allow suffixes.

- 140 Character data error;
This error is generated when parsing a character data element. This particular error message should be used if the device cannot detect a more specific error.

- 141 Invalid character data;
Either the character data element contains an invalid character or the particular element received is not valid for the header.

- 144 Character data too long;
The character data element contains more than twelve characters.

- 148 Character data not allowed;
A legal character data element was encountered where prohibited by the device.

Execution Conflict

The system messages listed below are execution conflicts, indicating settings conflict during your operation. These messages will be cleared from the screen by the signal generator automatically 30 seconds later since they were generated.

- 221 Setting conflict;
start frequency must be smaller than stop frequency.
- 221 Setting conflict;
start amplitude must be smaller than stop amplitude.
- 221 Setting conflict;
AM cannot be enabled with I/Q or pulse.
- 221 Setting conflict;
FM cannot be enabled together with Φ M.
- 221 Setting conflict;
LF cannot be enabled together with AM/FM/ Φ M/LF sweep.
- 221 Setting conflict;
Pulse width must be narrower than pulse period.
- 221 Setting conflict;
 Φ M deviation range is decided by Φ M rate.
- 221 Setting conflict;
AM carrier frequency cannot be lower than 100 kHz.
- 221 Setting conflict;
Modulation rate must be lower than carrier frequency.
- 222 Value clipped to upper limit.
- 222 Value clipped to lower limit.
- 255 Media/Directory full.

System Errors

- 310 System error;
write file error.
An attempt to write to a file has failed.

- 310 System error;
Recall file error.
Error encountered while loading system files.

- 310 System error;
Error detecting USB peripheral device.
Error encountered while attempt to detecting USB peripheral device. For example, Set **Catalog** to **USB** without USB device inserted.

- 310 System error;
File name exists, can not save current file.
Current file can not cover the existed file with the same file name.

- 313 Calibration memory lost;
Error locating calibration file.
An expected file was not found while trying to load internal calibration.

Hardware Errors

501 Mother board +15 V power supply failed.
501 Mother board -15 V power supply failed.
501 Mother board +24 V power supply failed.
501 Mother board +5 V power supply failed.
601 Digital board +5 V power supply failed.
601 Digital board +15 V power supply failed.
601 Digital board -15V power supply failed.
601 Digital board +5 V power supply failed.
601 Digital board -5V power supply failed.
601 Digital board +17V power supply failed.
601 Digital board +8.3V power supply failed.
601 Digital board +34V power supply failed.
602 Digital VCO failed.
Digital 100M VCO failed.
702 Analog board VCO unlock.
703 Analog board VCO 4G PLL unlocked.
704 Analog board level error at 4G-7G.
705 Analog board level error at 4G.
706 Analog board level error at 9k-3G.



8 Supplementary Information

Check the Basics	180
Read the warranty	181
Contact Agilent Technologies	182
List of Commands	183

Check the Basics

When you have any difficulties with your signal generator, please check with the following steps:

- Is there power at the power connector?
- Is the signal generator turned on? Listen for internal fan noise to determine if the cooling fan is running. Feel the right side of the signal generator to check for air flow.
- If you use other equipment, cables, and connectors with your signal generator, make sure you have connected them properly, and that they are operating correctly.
- Review your operation procedures from when the problem first appeared. Are all the settings correct?
- If the signal generator is not functioning as expected, return the signal generator to a known state by pressing  hardkey.
- Are the measurements and the results within the specification and capabilities of the signal generator? Refer to the *Technical Overview* for your generator.
- Is the signal generator displaying an error message? If so, refer to the [Chapter 7](#), “Instrument Messages”.

WARNING

There are no service components in the signal generator. To prevent Electrical shock, please don't disassemble your signal generator. Contact Agilent Technologies or professional service provider.

NOTE

A button cell provides power to the real time clock of the signal generator. It is not rechargeable. If you find your N9310A encounters a clock defect, please contact your nearest Agilent Customer Contact Center (CCC) for service.

Read the warranty

Agilent technologies provide one year warranty as standard for your signal generator. The warranty information for your signal generator is in the back of your *Technical Overview*. Please read it and become familiar with its terms.

If your signal generator is covered by a separate maintenance agreement, please be familiar with its terms.

Agilent Technologies offers several optional maintenance plans to service your signal generator after its warranty has expired. Call the nearest Agilent Technologies sales office for full details.

If you want to service the signal generator yourself after the warranty expires, you can purchase the service guide that provides all necessary test and maintenance information.

NOTE

The calibration cycle of N9310A RF signal generator is one year.

Contact Agilent Technologies

Agilent Technologies has offices around the world to provide you with complete support for your source. To obtain servicing information or to order replacement parts, contact the Agilent Technologies customer contact center listed below. In any correspondence or telephone conversations, refer to your signal generator by its product number and full serial number.

Online help: <http://www.agilent.com/find/assist>

United State

(tel) 800 829 4444
(fax) 800 829 4433

Canada

(tel) 877 894 4414
(fax) 800 746 4866

Europe

(tel) +31 20 547 2111

Korea

(tel) 080 769 0800
(fax) 080 769 0900

Japan

(tel) 0120 802 363
(fax) 0120 660 524

Latin America

(tel) +1 (305) 269 7500

China

(tel) 800 810 0189
(fax) 800 820 2816

Taiwan

(tel) 0800 047 866
(fax) 0800 286 331

Australia

(tel) 1 800 629 485
(fax) +61 (3) 9210 5947

Other Pacific Countries

(tel) +65 6375 8100
(fax) +65 6755 0042

E-mail: tm_ap@agilent.com

List of Commands

SCPI Command	Page #
:FREQuency:CW <val> <unit> :FREQuency:CW?	page 107
:FREQuency:RF:STARt <val> <unit> :FREQuency:RF:STARt?	page 108
:FREQuency:RF:STOP <val> <unit> :FREQuency:RF:STOP?	page 108
:FREQuency:LF:STARt <val> <unit> :FREQuency:LF:STARt?	page 109
:FREQuency:LF:STOP <val> <unit> :FREQuency:LF:STOP?	page 109
:FREQuency:RF:SCALe LOG LIN :FREQuency:RF:SCALe?	page 110
:AMPLitude:CW <val> <unit> :AMPLitude:CW?	page 111
:AMPLitude:STARt <val> <unit> :AMPLitude:STARt?	page 112
:AMPLitude:STOP <val> <unit> :AMPLitude:STOP?	page 112
:TRIGger:IMMediate	page 113
:TRIGger:SSWP	page 113
:SWEep:RF:STATe ON OFF 1 0 :SWEep:RF:STATe?	page 114
:SWEep:LF:STATe ON OFF 1 0 :SWEep:LF:STATe?	page 115
:SWEep:AMPLitude:STATe ON OFF 1 0 :SWEep:AMPLitude:STATe?	page 116
:SWEep:RF:STARt <val> <unit> :SWEep:RF:STARt?	page 117

SCPI Command	Page #
:SWEep:LF:START <val> <unit> :SWEep:LF:START?	page 118
:SWEep:RF:STOP <val> <unit> :SWEep:RF:STOP?	page 117
:SWEep:LF:STOP <val> <unit> :SWEep:LF:STOP?	page 118
:SWEep:AMPLitude:START <val> <unit> :SWEep:AMPLitude:START?	page 119
:SWEep:AMPLitude:STOP <val> <unit> :SWEep:AMPLitude:STOP?	page 119
:SWEep:STEP:POINTs <val> :SWEep:STEP:POINTs?	page 120
:SWEep:STEP:DWELl <val> <unit> :SWEep:STEP:DWELl?	page 120
:SWEep:REPeat SINGLE CONTInuous :SWEep:REPeat?	page 126
:SWEep:STRG IMMEDIATE EXT KEY :SWEep:STRG?	page 127
:SWEep:STRG:SLOPe EXTN EXTP :SWEep:STRG:SLOPe?	page 127
:SWEep:PTRG IMMEDIATE EXT KEY :SWEep:PTRG?	page 128
:SWEep:PTRG:SLOPe EXTN EXTP :SWEep:PTRG:SLOPe?	page 129
:SWEep:DIRectIon UP DOWN :SWEep:DIRectIon?	page 129
:AM:STATe ON OFF 1 0 :AM:STATe?	page 130
:AM:DEPTh <val> :AM:DEPTh?	page 131

SCPI Command	Page #
:AM:RATE <val> <unit> :AM:RATE?	page 131
:AM:SOURce INT EXT INT+EXT :AM:SOURce?	page 132
:AM:EXTCoupling AC DC :AM:EXTCoupling?	page 132
:FM:STATe ON OFF 1 0 :FM:STATe?	page 133
:FM:DEVIation <val> <unit> :FM:DEVIation?	page 134
:FM:RATE <val> <unit> :FM:RATE?	page 134
:FM:SOURce INT EXT INT+EXT :FM:SOURce?	page 135
:FM:EXTCoupling AC DC :FM:EXTCoupling?	page 135
:PM:STATe ON OFF 1 0 :PM:STATe?	page 136
:PM:DEVIation <val> <unit> :PM:DEVIation?	page 137
:PM:RATE <val> <unit> :PM:RATE?	page 137
:PULM:STATe ON OFF 1 0 :PULM:STATe?	page 138
:PULM:SOURce INT EXT :PULM:SOURce?	page 138
:PULM:PERIod <val> <unit> :PULM:PERIod?	page 139
:PULM:WIDTh <val> <unit> :PULM:WIDTh?	page 139

SCPI Command	Page #
:IQ:STATE ON OFF 1 0 :IQ:STATE?	page 140
:SYSTEM:DISPlay WHITE BLUE GREEN :SYSTEM:DISPlay?	page 141
:SYSTEM:ERRor?	page 141
:SYSTEM:SSAVer ON OFF 1 0 :SYSTEM:SSAVer?	page 142
:SYSTEM:DATE <year><month><day> :SYSTEM:DATE?	page 142
:SYSTEM:TIME <hour><minute> :SYSTEM:TIME?	page 143
:SYSTEM:REFErence:FREQuency INT10MHz EXT2MHz EXT5MHz EXT10MHz :SYSTEM:REFErence:FREQuency?	page 143
:SYSTEM:PNMD NORMAl RESFM	page 144
:MOD:STATE ON OFF 1 0 :MOD:STATE?	page 145
:RFOutput:STATE ON OFF 1 0 :RFOutput:STATE?	page 146
:LFOutput:STATE ON OFF 1 0 :LFOutput:STATE?	page 147
:LFOutput:FREQuency <val> <unit> :LFOutput:FREQuency?	page 148
:LFOutput:AMPLitude <val> <unit> :LFOutput:AMPLitude?	page 148

Index

Numerics

- 001,option, 3
- 1CM,option, 3
- 1TC,option, 3

A

- AC power cord
 - connection, 19
 - localization, 20
- Agilent Technologies
 - contact, 182
- AM, 54
 - annunciator, 7
 - depth, 55
 - example, 43
 - generate, 43
 - on/off, 54
 - rate, 55
 - source, 55
- Amplitude area, 7
- Amplitude hardkey, 4, 57
- annunciators, 7
- ARMED annunciator, 7
- arrow keys, 5, 58

B

- backspace, 66

C

- CE mark, 11

- check the shipment, 14

connectors

- I IN, 10
- LF Out, 6
- maintenance, 28
- MOD IN, 10
- PULSE MOD IN, 10
- Q IN, 10
- REF IN, 10
- REF OUT, 9
- RF Out, 5
- TRIG IN, 9
- USB device, 10
- USB Host, 9
- VGA, 10

- continous wave, 31
- CSA mark, 11
- c-tick mark, 11

D

- data, 30
- decimal point, 66
- display, 4
 - display style, 25
 - screen saver, 25

E

- enable option, 25
- Enter hardkey, 4, 58
- ERR annunciator, 7
- Error message, 24
- error message area, 8

- ESD, 21

F

- factory default settings, 70
- file, 59
 - catalog, 59
 - delete, 60
 - recall, 60
 - save, 60
- file name, 51
- firmware
 - update, 27
- FM, 61
 - deviation, 62
 - example, 44
 - ext coupling, 63
 - generate, 44
 - on/off, 61
 - rate, 62
 - source, 62
- frequency area, 7
- Frequency hardkey, 4, 64
- front panel overview, 4

H

- hardkeys
 - Preset, 70

Index

I

I/Q, 64
annunciator, 8
example, 48
generate, 47
instruction manual, 11
instrument state, 50
IO libraries suite, 26
ISM1-A, 11

K

knob, 5

L

LF
example, 49
generate, 49
sweep, 38
LF OUT, 65
ampl, 65
freq, 65
LF Out connector, 6

M

MOD IN, 10
Mod On/Off, 5
Mod On/Off hardkey, 66
modulation, 41
simultaneous, 42

N

numeric keypad, 6, 66

O

options
001, 3, 25, 64
1CM, 3
1TC, 3

P

Phase
generate, 45
phase, 67
on/off, 67
Phase example, 45
power on, 22
power switch, 9
pulse, 71
deviation, 67
example, 46
generate, 46
on/off, 71
period, 72
rate, 68
source, 71
width, 72
PULSE MOD IN, 10

R

rack mount, 15
rear panel overview, 9
requirements
electrical, 19
environmental, 18
ventilation, 18
RF On/Off, 5, 66
RF OUT connector, 5
RF sweep, 35

S

safety notice, 17
save, 50
local, 50
USB, 51
simultaneous modulation, 42
single sweep
initiate, 58
Softkeys, 4
softkeys, 30

sweep
amplitude, 37
configuration, 32
generate, 32
RF, 35
trigger, 33
switch, 68, 69
power, 69
standby, 6, 69
symbols, 11

T

text area, 8
TFT, 2
TRIG IN, 9
trigger
point, 81
sweep, 81

U

update, 27
USB Device Connectors, 6
USB Host connector, 9

V

ventilation, 18
VGA connector, 10

W

warranty, 181
WEEE, 12



Manufacturer's Name: Agilent-Qianfeng Electronic Technologies (Chengdu) Co., Ltd

Manufacturer's Address: Qianfeng Hi-Tech Industry Park,
Chengdu Hi-Tech Industrial Development Zone (West District),
Chengdu, 611731 P.R.C.

Declares under sole responsibility that the product as originally delivered

Product Name: RF Signal Generator
Model Number: N9310A
Product Options: This declaration covers all options of the above product(s).

complies with the essential requirements of the following applicable European Directives, and carries the CE marking accordingly:

Low Voltage Directive (73/23/EEC, amended by 93/68/EEC)
EMC Directive (89/336/EEC, amended by 93/68/EEC)

and conforms with the following product standards:

EMC	Standard	Limit
	IEC 61326-1:1997+A1:1998 / EN 61326-1:1997+A1:1998	
	CISPR 11:1990 / EN 55011:1991	Class A Group 1
	IEC 61000-4-2:1995+A1:1998 / EN 61000-4-2:1995	4 kV CD, 8 kV AD
	IEC 61000-4-3:1995 / EN 61000-4-3:1995	3 V/m, 80-1000 MHz
	IEC 61000-4-4:1995 / EN 61000-4-4:1995	0.5 kV signal lines, 1 kV power lines
	IEC 61000-4-5:1995 / EN 61000-4-5:1995	0.5 kV line-line, 1 kV line-ground
	IEC 61000-4-6:1996 / EN 61000-4-6:1996	3 V, 0.15-80 MHz
	IEC 61000-4-11:1994 / EN 61000-4-11:1994	1 cycle/ 100%
	Canada: ICES-001:1998	
	Australia/New Zealand: AS/NZS 2064.1	

This product was tested in a typical configuration with Agilent Technologies test systems.

Safety IEC 61010-1:2001 / EN 61010-1:2001
Canada: CSA C22.2 No. 61010-1:2004
USA: UL 61010-1: 2004

Supplementary Information:

This DoC applies to above-listed products placed on the EU market after:

July 1, 2006
Date

Shi Wen
Quality Manager

For further information, please contact your local Agilent Technologies sales office, agent or distributor, or Agilent Technologies Deutschland GmbH, Herrenberger Straße 130, D 71034 Böblingen, Germany.

www.agilent.com

© Agilent Technologies, Inc. 2006-2007

Printed in China

April 2007



N9310-90001



Agilent Technologies